

*Operator's Manual*  
*Coherent OBIS™*





*Operator's Manual*  
*Coherent OBIS*



**COHERENT®**

5100 Patrick Henry Drive  
Santa Clara, CA 95054

This document is copyrighted with all rights reserved. Under the copyright laws, this document may not be copied in whole or in part or reproduced in any other media without the express written permission of Coherent, Inc. Permitted copies must carry the same proprietary and copyright notices as were affixed to the original. This exception does not allow copies to be made for others, whether or not sold, but all the material purchased may be sold, given, or loaned to another person. Under the law, copying includes translation into another language.

Coherent, the Coherent Logo, and OBIS are trademarks or registered trademarks of Coherent, Inc. All other trademarks or registered trademarks are the property of their respective owners.

Patents referenced in this Operator's manual were active as of the printing date of the manual (see last page for date). The patents referenced herein may have expired. You are advised to check to see if the patents are still active: <http://portal.uspto.gov/external/portal/pair>.

Every effort has been made to ensure that the data given in this document is accurate. The information, figures, tables, specifications and schematics contained herein are subject to change without notice. Coherent makes no warranty or representation, either expressed or implied with respect to this document. In no event will Coherent be liable for any direct, indirect, special, incidental or consequential damages resulting from any defects in its documentation.

## **Technical Support**

### **In the US:**

Should you experience any difficulties with your laser or need any technical information, please visit our website: [www.Coherent.com](http://www.Coherent.com). Additional support can be obtained by contacting our Technical Support Hotline at 1.800.367.7890 (1.408.764.4557 outside the U.S.), or e-mail [Product.Support@Coherent.com](mailto:Product.Support@Coherent.com). Telephone coverage is available around the clock (except U.S. holidays and company shutdowns).

If you call outside our office hours, your call will be taken by our answering system and will be returned when the office reopens.

If there are technical difficulties with your laser that cannot be resolved by support mechanisms outlined above, e-mail, or telephone Coherent Technical Support with a description of the problem and the corrective steps attempted. When communicating with our Technical Support Department via the web or telephone, the Support Engineer responding to your request will require the model and Laser Head serial number of your laser system.

### **Outside the US:**

If you are located outside the U.S., visit our website for technical assistance or contact our local service representative. Representative phone numbers and addresses can be found on the Coherent website: [www.Coherent.com](http://www.Coherent.com).

Coherent provides telephone and web technical assistance as a service to its customers and assumes no liability thereby for any injury or damage that may occur contemporaneous with such services. These support services do not affect, under any circumstances, the terms of any warranty agreement between Coherent and the buyer. Operation of any Coherent laser with any of its interlocks defeated is always at the operator's own risk



# TABLE OF CONTENTS

Preface .....	xi
U.S. Export Control Laws Compliance .....	xi
Signal Words and Symbols in this Manual .....	xii
Signal Words .....	xii
Symbols .....	xiii
Receiving and Inspection .....	xiv
Traduction française .....	xv
Préface .....	xv
Conformité aux réglementations américaines sur le contrôle des exportations .....	xv
Mots indicateurs et symboles utilisés dans ce manuel .....	xvi
Mots indicateurs .....	xvi
Symboles .....	xvii
Réception et inspection .....	xviii
<b>Section One: Laser Safety .....</b>	<b>1-1</b>
Optical Safety .....	1-1
Electrical Safety .....	1-3
Laser Safety Features .....	1-4
CDRH/IEC 60825-1 Compliance .....	1-4
Declaration of Conformity—OBIS LX .....	1-6
Declaration of Conformity—OBIS LS .....	1-7
Laser Emission and Classification .....	1-8
Protective Housing .....	1-8
Remote Interlock .....	1-8
Key Control .....	1-10
Laser Emission Indicators .....	1-11
Radiation Exposure .....	1-11
Shutter .....	1-12
Waste Electrical and Electronic Equipment (WEEE, 2002) .....	1-13
Location of Safety Labels .....	1-14
RoHS Compliance .....	1-15
<b>French Translation/Traduction Française</b>	
<b>Première Section : Sécurité Laser .....</b>	<b>1-16</b>
Sécurité Optique .....	1-16
Sécurité Electrique .....	1-18
Lasers et dispositifs de sécurité .....	1-18
Conformité à la norme CDRH/IEC 60825-1 .....	1-18
Déclaration deconformité—OBIS LX .....	1-21
Déclaration deconformité—OBIS LS .....	1-22
Limites d'émission et classification laser .....	1-23
Boîtier protecteur .....	1-23
Verrouillage à distance .....	1-23
Interrupteur à clef .....	1-25

Indicateurs d'émission de laser .....	1-26
Exposition aux rayonnements .....	1-26
Mécanisme d'obturation .....	1-27
Waste Electrical and Electronic Equipment (WEEE, 2002) .....	1-27
Emplacement des étiquettes de sécurité .....	1-28
Conformité au RoHS .....	1-29

<b>Section Two: Description and Specifications .....</b>	<b>2-1</b>
System Description .....	2-2
Features .....	2-2
Laser Head .....	2-3
Front Panel .....	2-4
Back Panel .....	2-5
DC Supply Connector .....	2-6
Fan Connector .....	2-6
SDR Connector .....	2-6
USB Connector .....	2-7
Status LED Indicator .....	2-7
System Diagram .....	2-7
Configurations .....	2-8
OBIS Remote Status LED States .....	2-10
Specifications .....	2-10
Optional Heat Sink .....	2-11
Features .....	2-11
Power Supply for OBIS Laser or OBIS Remote .....	2-12
Specifications .....	2-12
OBIS Remote .....	2-13
Front Panel .....	2-13
Key Switch .....	2-14
Status LED Indicators .....	2-15
Interlock Jumper .....	2-15
Power ON/OFF Switch .....	2-16
Back Panel .....	2-16
Power In Connector .....	2-17
I/O Connector .....	2-17
SDR Connector .....	2-18
Modulation In Connectors .....	2-21
RS-232 Connector .....	2-21
USB Connector .....	2-22
Auto Start Switch .....	2-22
Interlock Control .....	2-23
Interface Cable .....	2-23
Laser Head Modulation .....	2-24
Specifications .....	2-24
OBIS 6-Laser Remote .....	2-25
Front Panel .....	2-26
Key Switch .....	2-26
Status LED Indicator .....	2-27

Power ON/OFF Switches.....	2-29
Back Panel .....	2-29
Power In Connector .....	2-29
Power Out Connectors .....	2-30
Interlock Jumper .....	2-30
Auto Start Jumper and Fuse Replacement.....	2-31
Remote Interlock.....	2-32
Interlock Control.....	2-32
Specifications.....	2-32
Humidity .....	2-33
Dimensions .....	2-34
<b>Section Three: Installation.....</b>	<b>3-1</b>
Overview of the Standard Installation Procedure .....	3-1
Installing the Optional Heat Sink.....	3-2
Mounting the Laser Head .....	3-5
Connecting the SDR Cable.....	3-9
Connecting Power.....	3-10
Adding Optional Fan Power .....	3-10
Connecting the Interlock.....	3-11
Connecting Optional USB/RS-232.....	3-11
Heat Sink Requirement.....	3-12
<b>Section Four: Operation.....</b>	<b>4-1</b>
Introduction.....	4-1
Hardware Setup.....	4-1
CW Operation .....	4-2
CW Constant Power Operation.....	4-2
CW Constant Current Operation.....	4-4
CW Operation by Analog Control .....	4-4
Pulsed Operation.....	4-5
Analog Modulation .....	4-6
Modulation Waveform Definitions .....	4-6
Digital Modulation.....	4-7
Mixed Modulation .....	4-8
USB and RS-232 Remote Control .....	4-10
<b>Section Five: Computer Control.....</b>	<b>5-1</b>
Connecting USB/RS-232 for Remote Control.....	5-1
USB Head Connections .....	5-1
USB Drivers.....	5-1
System Requirements .....	5-2
Installing the OBIS Software.....	5-2
<b>Section Six: Advanced Procedures.....</b>	<b>6-1</b>
CDRH Feature .....	6-1
Disabling CDRH Procedure.....	6-2

Enabling Auto Start.....	6-3
Installing and Operating the OEM Laser Head Only.....	6-4
Connecting Power and the Optional USB Cable.....	6-5
Adding Optional Fan Power.....	6-5
Mounting Hardware Recommendation.....	6-5
Power Supply Requirements.....	6-6
System Standby and Sleep Mode.....	6-6
OBIS Communications Through HyperTerminal.....	6-7
OBIS LX Firmware 2.X with OBIS Connection 2.x.....	6-9

**Section Seven: Host Interface** ..... 7-1

Host Command Quick Reference.....	7-1
Message Considerations.....	7-3
Communication Port Selection.....	7-3
Message Completion Handshake.....	7-4
Message Terminators.....	7-5
Messages Received by the Laser.....	7-5
Messages Sent by the Laser.....	7-5
Message Syntax.....	7-5
Device Selection Syntax.....	7-6
Command Prompt.....	7-7
Broadcast Commands.....	7-8
Commands and Queries.....	7-8
Mandatory Commands and Queries.....	7-9
IEEE-488.2 Mandated Commands/Queries.....	7-9
OBIS Mandatory Commands/Queries.....	7-10
Session Control Commands.....	7-10
OBIS Common Commands and Queries.....	7-15
System Information Queries.....	7-15
System State Commands/Queries.....	7-18
Operational Commands/Queries.....	7-19
OBIS Optional Commands.....	7-21
Set/Query TEC Enable.....	7-21
DDL-Specific Commands.....	7-21
Enable/Undo Laser Power Field Calibration.....	7-22
Internal Temperature Limit Queries.....	7-22
Diode Temperature Query.....	7-22
Diode Set Point Temperature Query.....	7-23
Internal Temperature Query.....	7-23
Controls and Queries.....	7-26

**Section Eight: Troubleshooting** ..... 8-1

Introduction.....	8-1
Troubleshooting Procedures.....	8-1
Checklist 1:	
No output power from the laser.....	8-2

Checklist 2:	
Laser output power is lower than expected. ....	8-3
Checklist 3:	
Base plate temperature error. ....	8-4
Checklist 4:	
The OBIS Remote is powered up and switched to the ON position, but the OBIS laser head is not emitting a beam and remains in Standby mode. ....	8-4
Checklist 5:	
The LED on top of the OBIS laser is not functioning. ....	8-4
<b>Section Nine: Repacking Procedure</b> .....	9-1
OBIS Repacking Procedure.....	9-2
OBIS FP Repacking Procedure.....	9-3
<b>Appendix A: Warranty</b> .....	A-1
Responsibilities of the Buyer.....	A-1
Limitations of Warranty.....	A-1
<b>Appendix B: Parts List</b> .....	B-1
<b>Appendix C: Accessories</b> .....	C-1
Power Meter Accessories.....	C-1
First Recommendation.....	C-1
Alternative Recommendation.....	C-2
<b>Glossary</b> .....	Glossary-1
<b>Index</b> .....	Index-1

## LIST OF FIGURES

1-1.	Remote Interlock Circuit and Key Switch Diagram (LX laser) .....	1-9
1-2.	OBIS Remote Key Switch .....	1-10
1-3.	Shutter Control: Open and Closed Positions .....	1-12
1-4.	OBIS FP with and without Fiber Shutter Cap .....	1-13
1-5.	Waste Electrical and Electronic Equipment Label.....	1-13
1-6.	Safety Labels.....	1-14
1-7.	China RoHS Table of Restricted Hazardous Substances.....	1-15
1-8.	China RoHS Date of Manufacture.....	1-15
1-9.	Diagramme du circuit de verrouillage et du commutateur à clef.....	1-24
1-10.	L'interrupteur à clef pour commande à distance OBIS.....	1-25
1-11.	Commande manuelle de l'obturateur en positions ouverte et fermée.....	1-27
1-12.	Étiquette portant le symbole de la directive << Waste Electrical and Electronic Equipment >> .....	1-27

1-13.	Etiquettes de Sécurité.....	1-28
1-14.	Tableau conforme à la directive chinoise RoHS indiquant les substances dangereuses soumises à des restrictions .....	1-29
1-15.	Date de fabrication pour la directive chinoise RoHS .....	1-29
2-1.	OBIS Laser System Components and Accessories.....	2-1
2-2.	Laser Head Front Panel.....	2-4
2-3.	Shutter Control: Open and Closed Positions .....	2-4
2-4.	OBIS FP Shutter Control: Open and Closed Positions.....	2-5
2-5.	Laser Head Back Panel .....	2-5
2-6.	DC Supply Connector Pin Location .....	2-6
2-7.	Fan Connector Pin Location .....	2-6
2-8.	SDR Connector .....	2-6
2-9.	USB Connector .....	2-7
2-10.	Status LED Indicator.....	2-7
2-11.	Optical Schematic (LS laser only).....	2-9
2-12.	Status LED Locations .....	2-10
2-13.	Optional Heat Sink.....	2-11
2-14.	Power Supply .....	2-12
2-15.	OBIS Remote Front Panel .....	2-13
2-16.	OBIS Remote Key Switch .....	2-14
2-17.	OBIS Remote Key Switch STANDBY and ON Positions .....	2-14
2-18.	OBIS Remote Status LED indicators.....	2-15
2-19.	OBIS Remote Interlock Jumper.....	2-15
2-20.	OBIS Remote Power ON/OFF Switch .....	2-16
2-21.	OBIS Remote Back Panel.....	2-16
2-22.	OBIS Remote Power In Connector.....	2-17
2-23.	OBIS Remote I/O Connector.....	2-17
2-24.	OBIS Remote SDR Connector .....	2-18
2-25.	OBIS Remote Modulation In Connectors.....	2-21
2-26.	OBIS Remote RS-232 Connector .....	2-21
2-27.	OBIS Remote USB Connector .....	2-22
2-28.	OBIS Remote Auto Start Switch .....	2-23
2-29.	OBIS 6-Laser Remote Front Panel .....	2-26
2-30.	OBIS 6-Laser Remote Key Switch.....	2-26
2-31.	OBIS 6-Laser Remote Key Switch STANDBY and ON Positions .....	2-27
2-32.	OBIS 6-Laser Remote Status LED Indicator.....	2-27
2-33.	OBIS 6-Laser Remote Power ON/OFF Switches.....	2-29
2-34.	OBIS 6-Laser Remote Back Panel.....	2-29
2-35.	OBIS 6-Laser Remote Main Power In Connector .....	2-29
2-36.	OBIS 6-Laser Remote Power Out Connectors .....	2-30
2-37.	OBIS 6-Laser Remote Interlock Jumper .....	2-30
2-38.	OBIS 6-Laser Remote Exploded View .....	2-31
2-39.	Optional Heat Sink Dimensions .....	2-35
2-40.	Laser Head Dimensions.....	2-36
2-41.	OBIS FP Laser Head Dimensions .....	2-37
2-42.	OBIS Remote Power Supply Dimensions .....	2-37

2-43.	OBIS 6-Laser Remote Power Supply Dimensions .....	2-38
2-44.	OBIS Remote Dimensions .....	2-39
2-45.	OBIS Remote (With Mounting Brackets) Dimensions .....	2-40
2-46.	OBIS 6-Laser Remote Dimensions .....	2-41
3-1.	Remove the Heat Sink Plugs .....	3-2
3-2.	Heat Sink Plug Locations .....	3-3
3-3.	Bolt the Heat Sink to the Proposed Laser Location .....	3-3
3-4.	Torque the Mounting Screws .....	3-4
3-5.	Connect the Fan to the OBIS Power Supply .....	3-4
3-6.	Replace the Heat Sink Plugs .....	3-5
3-7.	Provided Mounting Screw Kit for OBIS Laser Head .....	3-6
3-8.	Align the Laser Head to the Heat Sink .....	3-6
3-9.	Secure the Laser Head to the Heat Sink .....	3-7
3-10.	Tightening Pattern for Mounting the OBIS Laser Head .....	3-7
3-11.	Tighten the Mounting Screws .....	3-8
3-12.	Connecting the SDR Cable .....	3-9
3-13.	Connecting Power .....	3-10
3-14.	Adding Optional Fan Power to the Laser Head .....	3-10
3-15.	Connecting the Interlock .....	3-11
3-16.	Measured Thermal Dissipation Data of the OBIS Laser Head .....	3-12
3-17.	Maximum Thermal Impedance of Heat Sink Needed to Cool OBIS Laser .....	3-12
4-1.	Oscilloscope Traces of OBIS Laser Analog Modulation .....	4-7
4-2.	Oscilloscope Traces of OBIS Laser Digital Modulation .....	4-8
4-3.	Typical Rise and Fall Behavior of OBIS Laser Digital Modulation .....	4-8
4-4.	Oscilloscope Traces of OBIS Laser Mixed Modulation .....	4-9
4-5.	Enabling/Disabling Blanking through OBIS Connection .....	4-9
4-6.	OBIS LX Analog Modulation Blanking Circuit Diagram .....	4-10
5-1.	Connecting a USB or RS-232 Cable .....	5-1
6-1.	Enabling/Disabling CDRH Delay through OBIS Connection .....	6-2
6-2.	OBIS Remote Auto Start Switch Location .....	6-3
6-3.	OBIS LX Auto Start .....	6-3
6-4.	Connecting Power and the Optional USB Cable .....	6-5
6-5.	Adding Optional Fan Power to the Laser Head .....	6-5
9-1.	OBIS Shipping Container Showing Component Placement .....	9-2
9-2.	OBIS FP Shipping Container Showing Component Placement .....	9-3
9-3.	OBIS FP Laser Head Secured to the Mounting Plate .....	9-4

# LIST OF TABLES

1-1.	Safety Glass OD Table.....	1-1
1-2.	Maximum Emission of OBIS LS Lasers .....	1-2
1-3.	OBIS Remote Status LED States.....	1-10
1-4.	Tableau de densité optique (D.O.) des protections oculaires.....	1-16
1-5.	États de la DEL de la commande à distance OBIS.....	1-25
2-1.	Laser Head Configurations .....	2-8
2-2.	OBIS Remote Status LED States .....	2-10
2-3.	Power Supply Specifications .....	2-12
2-4.	I/O Connector Pinout Specifications .....	2-18
2-5.	OBIS Remote SDR Connector Specifications.....	2-18
2-6.	OBIS Remote SDR Cable Pinout Specifications.....	2-19
2-7.	OBIS Remote RS-232 Communication Settings.....	2-21
2-8.	OBIS Remote RS-232 Pin Connections .....	2-22
2-9.	Behavior During Laser Operation.....	2-23
2-10.	OBIS Remote Specifications .....	2-24
2-11.	OBIS 6-Laser Remote Status LED States.....	2-28
2-12.	OBIS 6-Laser Power Out Connector Pinout Specifications .....	2-30
2-13.	Behavior During Laser Operation.....	2-32
2-14.	OBIS 6-Laser Remote Specifications .....	2-32
2-15.	Safe Operating Humidity Levels (LX lasers only) .....	2-33
4-1.	OBIS LS Modulation Types.....	4-3
4-2.	RS-232 Pin Connections.....	4-10
4-3.	RS-232 Communication Settings.....	4-10
4-4.	Factory Default Settings .....	4-11
4-5.	Status Code Bit Definitions .....	4-11
4-6.	Error Codes and Description Strings .....	4-12
6-1.	Auto Start (at Moment of Power On) .....	6-4
7-1.	Host Command Quick Reference .....	7-1
7-2.	Supported Commands by Laser Type.....	7-8
7-3.	Status Code Bit Definitions .....	7-11
7-4.	Fault Code Bit Definitions.....	7-13
7-5.	Fault Codes—OBIS Remote (Mini) and Laser Head (LH) .....	7-23
7-6.	OBIS Control Commands.....	7-27
7-7.	OBIS Query Commands .....	7-28
8-1.	Troubleshooting Procedures .....	8-1
9-1.	Components Shipped with Different OBIS Laser System Configurations.....	9-1
B-1.	Parts List .....	B-1



## Preface

This manual contains user information for the Coherent OBIS laser system, which consists of a laser head and an OBIS Remote.



---

### **WARNING!**

**Use of controls or adjustments or performance of procedures other than those specified herein may result in hazardous radiation exposure.**

---



---

### **NOTICE!**

**Read this manual carefully before operating the laser for the first time. Special attention should be given to the material in “Section One: Laser Safety” (p. 1-1), which describes the safety features built into the laser.**

---

## **U.S. Export Control Laws Compliance**

It is the policy of Coherent to comply strictly with U.S. export control laws.

Export and re-export of lasers manufactured by Coherent are subject to U.S. Export Administration Regulations, which are administered by the Commerce Department. In addition, shipments of certain components are regulated by the State Department under the International Traffic in Arms Regulations.

The applicable restrictions vary depending on the specific product involved and its destination. In some cases, U.S. law requires that U.S. Government approval be obtained prior to resale, export or re-export of certain articles. When there is uncertainty about the obligations imposed by U.S. law, clarification should be obtained from Coherent or an appropriate U.S. Government agency.

## Signal Words and Symbols in this Manual

This documentation may contain sections in which particular hazards are defined or special attention is drawn to particular conditions. These sections are indicated with signal words in accordance with ANSI Z-535.6 and safety symbols (pictorial hazard alerts) in accordance with ANSI Z-535.3 and ISO 7010.

### Signal Words

Four signal words are used in this documentation: **DANGER**, **WARNING**, **CAUTION** and **NOTICE**.

The signal words **DANGER**, **WARNING** and **CAUTION** designate the degree or level of hazard when there is the risk of injury:

---

#### **DANGER!**

Indicates a hazardous situation that, if not avoided, will result in death or serious injury. This signal word is to be limited to the most extreme situations.

---

---

#### **WARNING!**

Indicates a hazardous situation that, if not avoided, could result in death or serious injury.

---

---

#### **CAUTION!**

Indicates a hazardous situation that, if not avoided, could result in minor or moderate injury.

---

The signal word "**NOTICE**" is used when there is the risk of property damage:

---

#### **NOTICE!**

Indicates information considered important, but not hazard-related.

---

Messages relating to hazards that could result in both personal injury and property damage are considered safety messages and not property damage messages.

## Symbols

The signal words **DANGER**, **WARNING**, and **CAUTION** are always emphasized with a safety symbol that indicates a special hazard, regardless of the hazard level:



---

**This symbol is intended to alert the operator to the presence of important operating and maintenance instructions.**

---



---

**This symbol is intended to alert the operator to the danger of exposure to hazardous visible and invisible laser radiation.**

---



---

**This symbol is intended to alert the operator to the presence of dangerous voltages within the product enclosure that may be of sufficient magnitude to constitute a risk of electric shock.**

---



---

**This symbol is intended to alert the operator to the danger of Electro-Static Discharge (ESD) susceptibility.**

---



---

**This symbol is intended to alert the operator to the danger of crushing injury.**

---



---

**This symbol is intended to alert the operator to the danger of a lifting hazard.**

---

## Receiving and Inspection

Inspect shipping boxes for signs of rough handling or damage and indicate any such signs on the bill of lading. Report any damage immediately to the shipping carrier and to either Coherent Order Administration Department at 1.800.367.7890 (outside the U.S.: 1.408.764.4557), or to an authorized Coherent representative.

The following table lists the components shipped with the different OBIS laser system configurations.

Item Description	Included With				
	OEM Laser	Laser System	OBIS Remote	OBIS 6-Laser Remote	Spare Parts Accessory Bag
Laser head	X	X			
Laser mounting bolts/washers (4 each)	X	X			
OBIS Remote		X	X		
OBIS 6-Laser Remote				X	
Laser Safety and Software Installation Guide	X	X	X		X
Keys for OBIS Remote (2 each)		X	X	X	X
Interlock, shorted, for OBIS Remote		X	X	X	X
Wavelength labels for OBIS Remote		X	X	X	X
Flash stick for software control		X	X	X	X
Mounting brackets/hardware for OBIS Remote		X	X	X	
Cable, SDR, laser head to OBIS Remote (1 meter)		X			
USB cable, Type A to Type Mini-B (1.8 meters)		X	X		
Power supply, 110/220V AC, 12V DC, IEC-320		X	X	X	
Power cord, USA to IEC-320		X	X	X	
Cable, 8-pin, I/O for OBIS Remote (1 meter)					X
Cable, 2-pin, power for OBIS 6-Laser Remote (1 meter) (6 each)				X	X
Heat sink, with fan/hardware	order separately				
Laser emission indicator with interlock connector	order separately				
Cable, SDR, laser head to OBIS Remote (3 meters)	order separately				




---

**NOTICE!**

After unpacking the system, save the shipping boxes for potential later shipments—refer to “Section Nine: Repacking Procedure” (p. 9-1) for repacking instructions.

---

## Traduction française

### Préface

Ce manuel contient les informations destinées à l'utilisateur du système laser OBIS, conçu par la firme Coherent, qui consiste en une tête laser et un mini contrôleur.



---

#### **AVERTISSEMENT !**

**L'utilisation de procédures de contrôle ou de réglage des performances autres que celles spécifiées ci-après peut entraîner un risque d'exposition dangereuse au rayonnement laser.**

---



---

#### **AVIS !**

**Lire attentivement ce manuel avant d'utiliser le laser pour la première fois. Une attention particulière devra être portée à la Section 1, Sécurité Laser, qui décrit les précautions à prendre avec le laser.**

---

### Conformité aux réglementations américaines sur le contrôle des exportations

Coherent observe strictement les réglementations américaines en matière de contrôle des exportations.

L'exportation et la revente des lasers fabriqués par Coherent sont soumises aux lois et règlements régissant les exportations au départ des États-Unis. De plus, l'envoi de certains composants est réglementé par le Département d'État des USA en vertu des traités internationaux concernant le trafic d'armes.

Les restrictions peuvent varier selon le produit spécifié et sa destination. Dans certains cas, la loi américaine impose l'obtention préalable de l'approbation du gouvernement américain pour la vente, l'exportation ou la revente.

S'il y a doute quant aux obligations imposées par la loi des États-Unis, une clarification doit être obtenue auprès de Coherent ou d'une agence gouvernementale appropriée.

## **Mots indicateurs et symboles utilisés dans ce manuel**

La présente documentation peut contenir des sections dans lesquelles des dangers particuliers sont définis ou une attention spéciale est portée à des conditions spécifiques. Ces sections sont signalées par des mots indicateurs, conformément à la norme ANSI Z-535.6, ainsi que des symboles de sécurité (alertes de danger par pictogramme) conformément aux normes ANSI Z-535.3 et ISO 7010.

### **Mots indicateurs**

Cette documentation fait usage de quatre mots indicateurs: **DANGER**, **AVERTISSEMENT**, **MISE EN GARDE** et **AVIS**.

Les mots indicateurs **DANGER**, **AVERTISSEMENT** et **MISE EN GARDE** indiquent le degré ou niveau de danger en présence d'un risque immédiat de blessures graves :

---

#### **DANGER !**

**Indique une situation dangereuse qui, si elle n'est pas évitée, entraînera la mort ou des blessures graves. Ce mot indicateur est réservé aux situations les plus graves.**

---

---

#### **AVERTISSEMENT !**

**Indique une situation dangereuse qui, si elle n'est pas évitée, peut entraîner la mort ou des blessures graves.**

---

---

#### **MISE EN GARDE !**

**Indique une situation dangereuse qui, si elle n'est pas évitée, pourrait entraîner des blessures légères ou modérées.**

---

Le mot indicateur "**AVIS**" est utilisé lorsqu'un risque de dommages matériels existe :

---

#### **AVIS !**

**Indique des informations considérées comme importantes, mais ne constituant pas un danger.**

---

Les messages relatifs aux dangers pouvant entraîner à la fois des blessures et des dommages matériels sont considérés comme des messages concernant la sécurité et non comme des messages avertissant de la possibilité de dégâts matériels.

## Symboles

Les mots indicateurs **DANGER**, **AVERTISSEMENT**, et **MISE EN GARDE** sont toujours mis en évidence par la présence d'un symbole de sécurité indiquant un danger spécifique, sans égard au niveau de ce danger :



---

Ce symbole est destiné à alerter l'opérateur de la présence d'instructions importantes concernant le fonctionnement ou l'entretien/la réparation.

---



---

Ce symbole est destiné à alerter l'opérateur de l'existence de risques d'exposition aux radiations laser, visibles ou invisibles.

---



---

Ce symbole est destiné à alerter l'opérateur de l'existence de tensions dangereuses à l'intérieur du boîtier ou carter de l'appareil, d'une importance suffisante pour constituer un risque d'électrocution.

---



---

Ce symbole est destiné à alerter l'opérateur de l'existence de décharges électrostatiques (DES).

---



---

Ce symbole est destiné à alerter l'opérateur de l'existence d'un danger d'écrasement.

---



---

Ce symbole est destiné à alerter l'opérateur de l'existence d'un risque de levage.

---

## Réception et inspection

Inspecter les caisses et emballages d'expédition et noter toutes traces de manutention brutale ou de dommages et en porter mention sur la lettre de transport. Faire immédiatement rapport de tout dommage au transporteur et, soit au département de gestion des commandes de Coherent (Order Administration Department) au numéro 1 (408) 764-4557 (aux États-Unis, au 1-800-367-7890) ou au représentant autorisé de Coherent.

Item Description	Included With				
	OEM Laser	Laser System	OBIS Remote	OBIS 6-Laser Remote	Spare Parts Accessory Bag
Laser head	X	X			
Laser mounting bolts/washers (4 each)	X	X			
OBIS Remote		X	X		
OBIS 6-Laser Remote				X	
Laser Safety and Software Installation Guide	X	X	X		X
Keys for OBIS Remote (2 each)		X	X	X	X
Interlock, shorted, for OBIS Remote		X	X	X	X
Wavelength labels for OBIS Remote		X	X	X	X
Flash stick for software control		X	X	X	X
Mounting brackets/hardware for OBIS Remote		X	X	X	
Cable, SDR, laser head to OBIS Remote (1 meter)		X			
USB cable, Type A to Type Mini-B (1.8 meters)		X	X		
Power supply, 110/220V AC, 12V DC, IEC-320		X	X	X	
Power cord, USA to IEC-320		X	X	X	
Cable, 8-pin, I/O for OBIS Remote (1 meter)					X
Cable, 2-pin, power for OBIS 6-Laser Remote (1 meter) (6 each)				X	X
Heat sink, with fan/hardware	order separately				
Laser emission indicator with interlock connector	order separately				
Cable, SDR, laser head to OBIS Remote (3 meters)	order separately				



### **AVIS !**

**Après le déballage du système, conserver caisses et emballages pour réexpédition ultérieure éventuelle - voir " Procédure de remballage " (p. 9-1).**



# SECTION ONE: LASER SAFETY

In this section:

- Optical safety (this page)
- Electrical safety (p. 1-3)
- Laser safety features (p. 1-4)
- French Translation (p. 1-16)

## Optical Safety

Because of its special properties, laser light poses safety hazards not associated with light from conventional sources. The safe use of lasers requires that all laser users, and everyone near the laser system, are aware of the dangers involved. The safe use of the laser depends upon the user being familiar with the instrument and the properties of coherent, intense beams of light.




---

### **DANGER!**

**Direct eye contact with the output beam from the laser will cause serious damage to the eye and possible blindness.**

---

*Table 1-1. Safety Glass OD Table*

Wavelength (nm)	Power (mW)	Div (Typ - mrad)	OD	IEC Classification
375	< 20	0.7	> 1.3	3B
405	< 200	0.8	> 2.1	3B
445	< 100	0.8	> 2.0	3B
473	< 80	0.9	> 1.9	3B
488	< 150	0.9	> 1.8	3B
637	< 160	1.0	> 2.5	3B
640	< 150	1.2	> 2.2	3B
647	< 180	0.97	> 2.5	3B
660	< 150	1.2	> 2.2	3B
685	< 100	0.97	> 2.1	3B
730	< 50	0.97	> 1.9	3B
785	< 100	1.4	> 2.3	3B

**Table 1-2. Maximum Emission of OBIS LS Lasers<sup>a</sup>**

<b>Laser</b>	<b>Wavelength</b>	<b>Max. Power</b>
488	0.45 to 0.50 $\mu\text{m}$	< 350 mW
	0.90 to 1.00 $\mu\text{m}$	< 50 mW
	0.79 to 0.82 $\mu\text{m}$	< 20 mW
514	0.50 to 0.52 $\mu\text{m}$	< 350 mW
	0.90 to 1.00 $\mu\text{m}$	< 50 mW
	0.79 to 0.82 $\mu\text{m}$	< 20 mW
552	0.54 to 0.56 $\mu\text{m}$	< 350 mW
	0.90 to 1.00 $\mu\text{m}$	< 50 mW
	0.79 to 0.82 $\mu\text{m}$	< 20 mW

a. The OBIS LS (=OPSL based) laser may also emit 0.9 to 1  $\mu\text{m}$  wavelength from the aperture in the front of the laser head. Collinear radiation of 0.79 to 0.82  $\mu\text{m}$  may also be present.

Laser beams can ignite volatile substances such as alcohol, gasoline, ether and other solvents, and can damage light-sensitive elements in video cameras, photomultipliers and photodiodes. Reflected beams may also cause damage. For these reasons, and others, the user is advised to follow the precautions below.

1. Observe all safety precautions in the Operator's manual.
2. Extreme caution must be exercised when using solvents in the area of the laser.
3. Limit access to the laser to qualified users who are familiar with laser safety practices and who are aware of the dangers involved.
4. Never look directly into the laser light source or at scattered laser light from any reflective surface. Never sight down the beam into the source.
5. Maintain experimental setups at low heights to prevent inadvertent beam-eye encounter at eye level.




---

**WARNING!**

**Laser safety glasses can present a hazard as well as a benefit; while they protect the eye from potentially damaging exposure, they block light at the laser wavelengths, which prevents the operator from seeing the beam. Therefore, use extreme caution even when using safety glasses.**

---

6. As a precaution against accidental exposure to the output beam or its reflection, those using the system must wear laser safety glasses as required by the wavelength being generated.
7. Use the laser in an enclosed room. Laser light will remain collimated over long distances and therefore presents a potential hazard if not confined.
8. Post warning signs in the area of the laser beam to alert those present.
9. Advise everyone using the laser of these precautions. It is good practice to operate the laser in a room with controlled and restricted access.
10. During the laser alignment process, do not wear items with reflective surfaces (for example, a watch or jewelry).

## **Electrical Safety**

The OBIS laser system does not contain hazardous voltages. Do not disassemble the enclosure. There are no user-serviceable components inside. All units are designed to be operated as assembled. Warranty will be voided if the enclosure is disassembled.



---

### **CAUTION!**

**Electrostatic charges as high as 4000V readily accumulate on the human body and equipment and can easily discharge without detection. Although the electronics features have impressive input protection, permanent damage may occur on devices subjected to high-energy electrostatic discharges. Therefore, proper ESD precautions are recommended to avoid performance degradation.**

**The most common ESD damage occurs while handling the device during installation or use. Take the necessary measures to protect the system from ESD.**

**Dry air and carpet can create an even higher potential for ESD. Precautions or shielding need to be taken for demonstrations or trade show exhibitions.**

---

## Laser Safety Features

### CDRH/IEC 60825-1 Compliance

When used with the OBIS Remote, the OBIS laser head complies with CDRH (21 CFR 1040.10 and 1040.11, except for deviations pursuant to laser notice no. 50, dated July 26, 2001) and IEC 60825-1. To view a list of CDRH accession numbers that were current as of the publication date of this document, open the *141037 rAA - OBIS CDRH Accession Numbers.pdf* file on the OBIS flash drive that shipped with your product. To view the most current list of accession numbers, connect to the following website: <http://www.coherent.com/Products/index.cfm?1884/OBIS-Lasers>.

In addition to complying with CDRH and IEC 60825-1 requirements, the OBIS family of products has been certified by an outside testing lab to be in compliance with the environmental and safety directives listed below.

#### **EMI Standard for Emissions per:**

*EN55011:2007*

Class A Radiated Emissions

*EN55011:2007*

Class A Conducted Emissions

*EN61000-3-2:2006*

Power Line Harmonics

*EN61000-3-3:1995:A1:2001:A2:2005*

Power Line Voltage Fluctuation and Flicker

#### **EMC Standard for Immunity per:**

*EN61000-4-2:2003*

Electrostatic Discharge – Performance Criteria B

*EN61000-4-3:2006*

Radiated Immunity – Performance Criteria A

*EN61000-4-4:2004*

Electrical Fast Transient Immunity – Performance Criteria B

*EN61000-4-5:2004*

Electrical Slow Transient Immunity – Performance Criteria B

*EN61000-4-6:2003*

Conducted RF Immunity – Performance Criteria A

*EN61000-4-11:2004*

Power Line Interruptions, Dips, and Dropouts – Performance Criteria B

**Low Voltage Directive 73/23/EEC Tests per:**

*EN61010-1:2001*

Safety Requirements Part 1: General Requirements

**MD – Machinery Directive for Laser Devices Tests per:**

*EN60825-1:2001*

Safety of Laser Products – Part 1: Equipment Classification  
Requirement and User's Guide

*EN60825-2:2005*

Safety of Laser Products – Part 2: Safety of Optical Fiber  
Communication Systems

*EN60825-12:2004*

Safety of Laser Products – Part 12: Safety of Free Space Optical  
Communication Systems Used for Transmission of Information

*21CFR 1040.10*

**Declaration of  
Conformity—OBIS  
LX**

D141153

Revision AA

## Declaration of Conformity

We

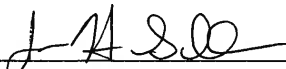
Coherent, Inc.  
27650 SW 95<sup>th</sup> Ave  
Wilsonville, Oregon, USA 97070

declare under sole responsibility that the

**OBIS Laser Family**

meets the intent of Directives 2004/108/EC for Electromagnetic Compatibility and 2006/95/EEC for Product Safety for Measurement, Control and Laboratory Equipment including the following test specifications:

- EN55011:2007 Class A Radiated Emissions
- EN55011:2007 Class A Conducted Emissions
- EN61000-3-2:2006 Powerline Harmonics
- EN61000-3-3:1995:A1:2001:A2:2005 Powerline Voltage Fluctuation and Flicker
- EN61000-4-2:2003 Electrostatic Discharge – Performance Criteria B
- EN61000-4-3:2006 Radiated Immunity – Performance Criteria A
- EN61000-4-4:2004 Electrical Fast Transient Immunity - Performance Criteria B
- EN61000-4-5:2005 Electrical Slow Transient Immunity- Performance Criteria B
- EN61000-4-6:2006 Conducted RF Immunity - Performance Criteria A
- EN61000-4-11:2004 Power Line Interruptions, Dips, and Dropouts - Performance Criteria B
- EN61010-1:2001 Safety Requirements Part 1: General Requirements
- EN60825-1:2007 Safety of Laser Products – Part 1: Equipment Classification Requirement and User's Guide
- EN60825-2:2005 Safety of Laser Products – Part 2: Safety of Optical Fiber Communication Systems
- EN60825-12:2004 Safety of Laser Products – Part 12: Safety of Free Space Optical Communication Systems Used for Transmission of Information

  
\_\_\_\_\_  
Director of Engineering

Date: 1/31/11

  
\_\_\_\_\_  
Vice President, LSM

Date: 1/31/11

Coherent, Inc.

# Declaration of Conformity—OBIS LS

## EG-Konformitätserklärung

Für das folgend bezeichnete Erzeugnis

## EC Declaration of Conformity

For the following named product

### Coherent OBIS LS

bestehend aus Laserkopf und Netzteil, wird hiermit bestätigt, dass es den grundlegenden Anforderungen entspricht, die in der Richtlinie des Rates zur Angleichung der Rechtsvorschriften der Mitgliedsstaaten über die elektromagnetische Verträglichkeit (2004/108/EG), sowie der Niederspannungsrichtlinie (2006/95/EG) festgelegt sind.

Das o.g. Erzeugnis ist zur Erfüllung der Anforderungen gemäß EN 60825-1:2007 ausgerüstet. Die tatsächliche Erfüllung der EN 60825-1:2007 obliegt dem Integrator.

Diese Erklärung bezieht sich auf alle Exemplare, die dem Fertigungsstand ab dem folgenden Datum entsprechen:

Sept. 13th 2011

Zur Beurteilung des Erzeugnisses hinsichtlich elektromagnetischer Verträglichkeit wurden folgende Normen herangezogen

EN 55022, Kl.B (05.08),  
EN 61000-4-2 (12.09),  
EN 61000-4-3 (06.08),  
EN 61000-4-4 (07.05),  
EN 61000-4-5 (06.07),  
EN 61000-4-6 (12.09)

Zur Beurteilung des Erzeugnisses hinsichtlich der Niederspannungsrichtlinie wurden folgende Normen herangezogen :

EN 61010-1: 2001

Diese Erklärung wird verantwortlich für den Hersteller

consisting of laser head and power supply, we declare that it complies with the basic requirements defined in the EC Directive on the harmonization of the laws of member states relating to electromagnetic compatibility (2004/108/EG) and the low voltage directive (2006/95/EG).

The above mentioned product is equipped to comply with EN 60825-1:2007. The actual compliance to EN 60825-1:2007 is the obligation of the integrator.

This declaration pertains to all products which are manufactured according to the manufacturing procedures valid on:

The following standards were used to assess the product concerning electromagnetic compatibility

EN 55022, Kl.B (05.08),  
EN 61000-4-2 (12.09),  
EN 61000-4-3 (06.08),  
EN 61000-4-4 (07.05),  
EN 61000-4-5 (06.07),  
EN 61000-4-6 (12.09)

The following standards were used to assess the product concerning low voltage compatibility:

EN 61010-1 : 2001

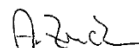
This declaration is given in account for the manufacturer

Coherent GmbH  
Niederlassung / Branch Luebeck  
Seelandstraße 9  
23569 Lübeck, Germany

abgegeben durch  
Andreas Zuck, Produktmanager

by  
Andreas Zuck, Product Line Manager

Lübeck, Sept. 13th 2011



**Laser Emission and Classification**

The OBIS laser system is classified by the United States National Center for Device and Radiological Health (CDRH) as a CLASS IIIb laser product. It may emit VISIBLE or INVISIBLE LASER RADIATION wavelengths of 0.3 to 1.0  $\mu\text{m}$  from the aperture in the front of the laser head.

**Protective Housing**

The laser radiation is entirely contained within a metal protective housing, except for the laser beam aperture. The protective housing should never be opened.

**Remote Interlock**

The OBIS Remote and the OBIS 6-Laser Remote are provided with a remote interlock circuit that prevents the generation of laser radiation when open. This interlock circuit is fail-safe or redundant. Figure 1-1 (p. 1-9) shows a diagram of the remote interlock circuit configuration. The interlock is located on the OBIS Remote and the OBIS 6-Laser Remote and is applicable to LS and LX systems.



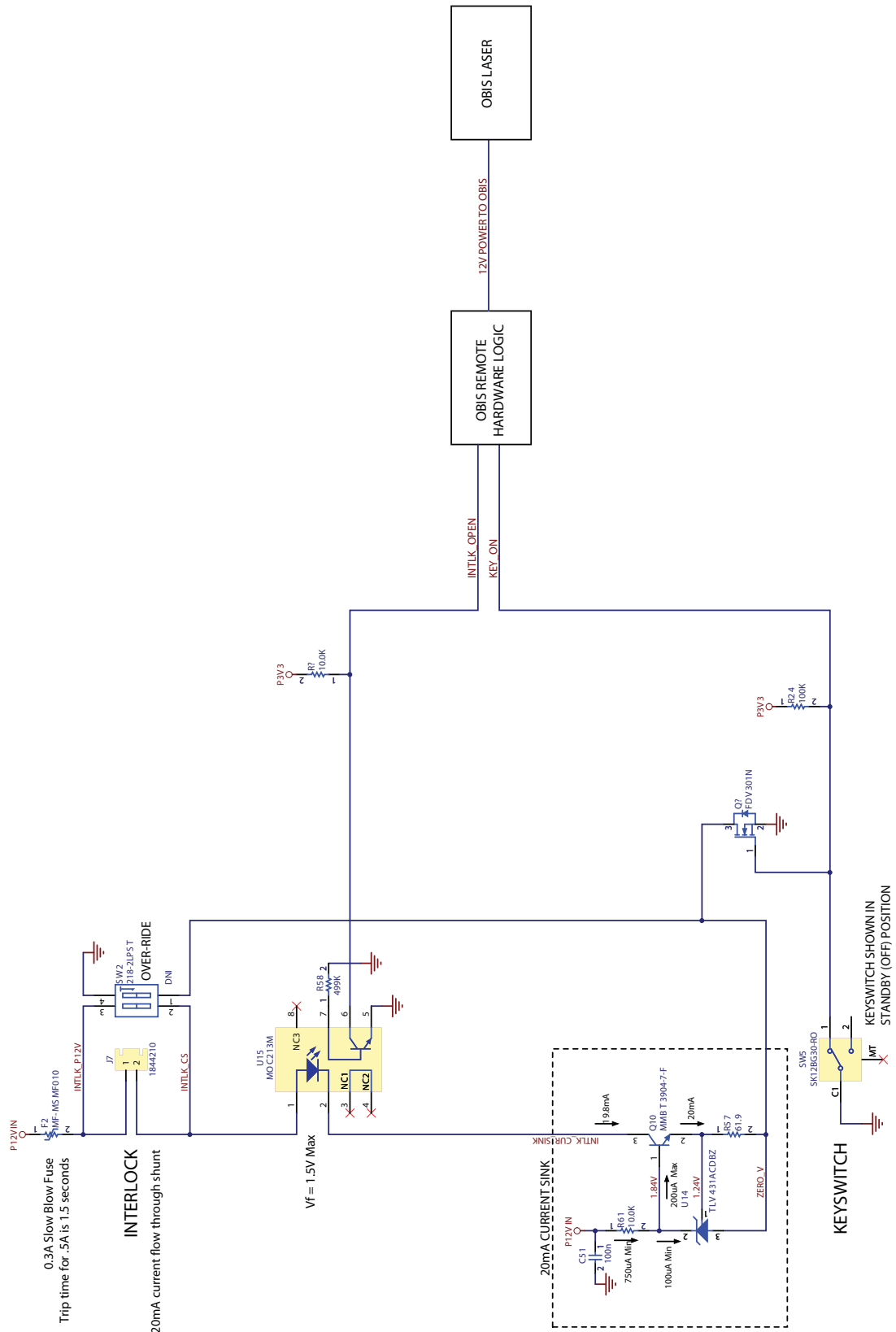
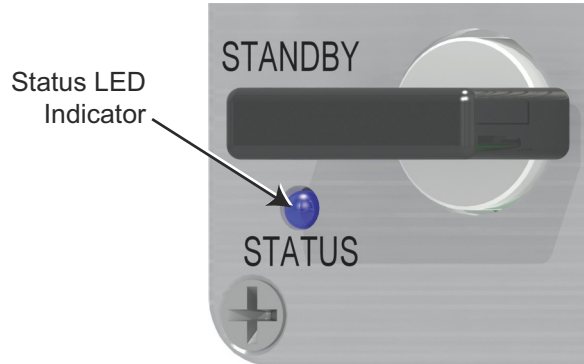


Figure 1-1. Remote Interlock Circuit and Key Switch Diagram (LX laser)

## Key Control

The OBIS Remote is provided with a keyswitch that prevents the generation of laser radiation when it is in the STANDBY position. Laser radiation may occur when the key is in the ON position. The key is removable when in the STANDBY position; it is not removable when it is in the ON position.



**Figure 1-2. OBIS Remote Key Switch**

The keyswitch acts as the CDRH Manual Reset feature: After an interlock fault or power interruption, the laser will not auto restart unless the keyswitch is first reset to STANDBY and then set back to ON. Figure 1-1 (p. 1-9) contains the keyswitch circuit information.

The Status LED indicator on the front panel displays green, blue, or red, as determined by the state of the OBIS Remote. *For information about the OBIS 6-Laser Remote Status LED indicator, refer to “Status LED Indicator” (p. 2-7).*

The table below is the truth table for the LED indicator on the OBIS Remote.

**Table 1-3. OBIS Remote Status LED States<sup>a</sup>**

Mode	LED Status	Internal Auto Start Jumper	Key Switch Position	Interlock Status
1	Blue	Out	STANDBY	X
2	Blinking Blue	Out	ON at power up	X
3	Green	Out	Cycle STANDBY to ON	Closed
4	Blue	In	STANDBY	X
5	Green	In	ON	Closed
6	Red	X	ON	Open

a. OBIS Single-Laser Remote units shipped between 2010 and 2012 may not have the Status LED indicator that has been incorporated into the latest design.

For more information, refer to Table 2-11 (p. 2-28).



---

**WARNING!**

**When the key switch is in the ON position, the interlock plug is connected, and the laser power switches are in the ON position and illuminated, there is a possibility of laser emission.**

---

## **Laser Emission Indicators**

The laser system OBIS Remote provides a laser emission indicator, which is located on the front panel. When the white LED emission indicator is not illuminated, laser radiation is not possible. When the indicator is illuminated, the laser should be considered dangerous; a laser beam may be created at any instant (via computer control, for example). After the illumination of the white LED emission indicator, there is a delay until actual laser emission, which allows appropriate action to avoid exposure to the laser beam. The delay is at least five seconds in duration.

---

**The LED indicator on the front panel of the OBIS 6-Laser Remote is NOT a laser emission indicator, but an indicator for the status of the remote—see Table 2-11 (p. 2-28).**

---

## **Radiation Exposure**



---

**WARNING!**

**Use of controls, adjustments, or performance of procedures other than those specified in this manual, may result in hazardous radiation exposure.**

---

## Shutter

The laser contains a manually-operated shutter at the beam exit aperture on the front of the laser head. When the shutter is fully closed, there is no laser radiation emitted from the laser.

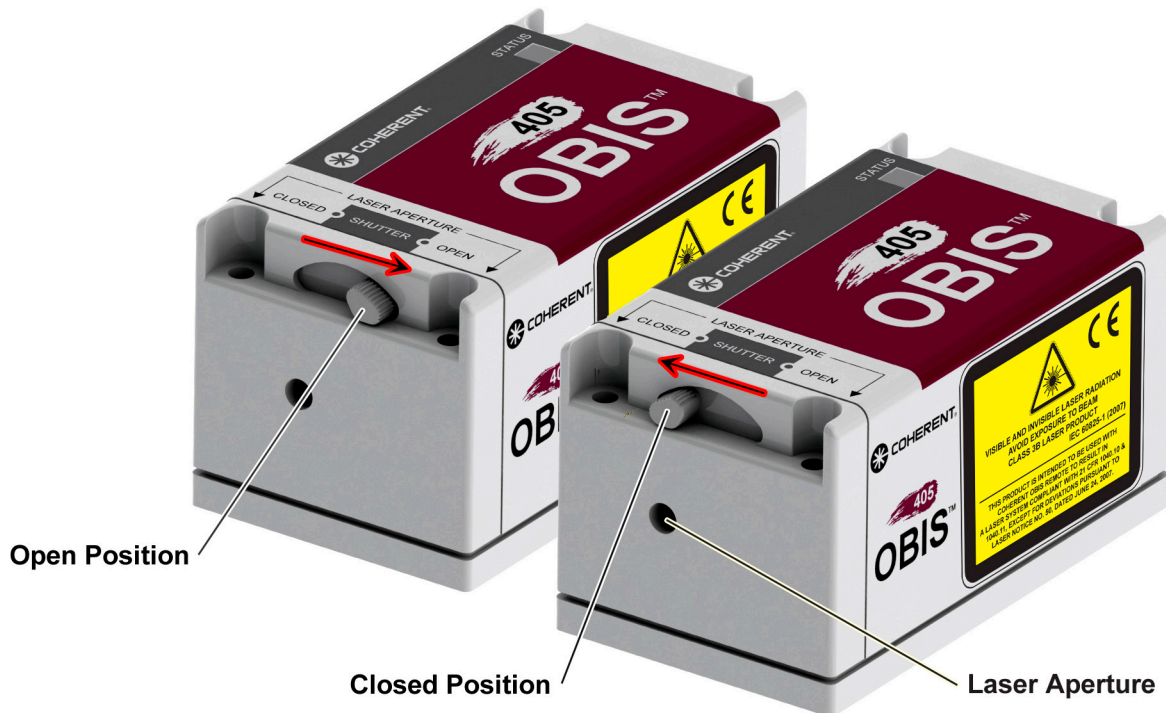


Figure 1-3. Shutter Control: Open and Closed Positions



---

**NOTICE!**

**OBIS FP: Always use nitrile gloves when handling the fiber output—do not touch the laser fiber output!**

---

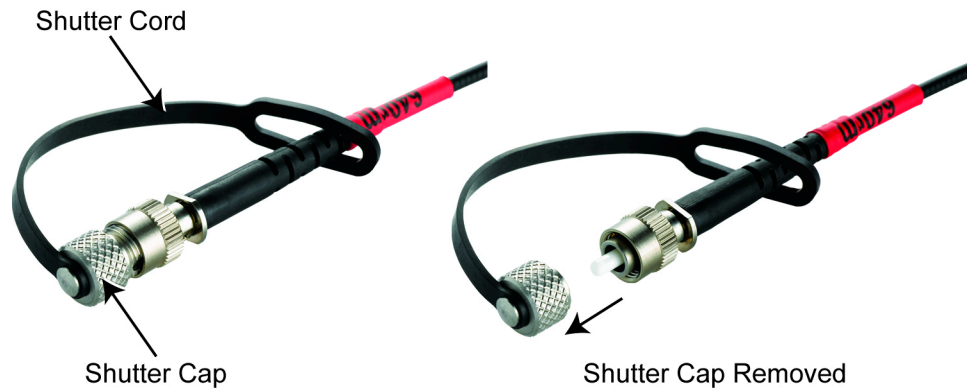


---

**NOTICE!**

**OBIS FP: Open fiber end in an environment that is free of organic material and particulates. The fiber end is susceptible to contamination that can lead to fiber degradation.**

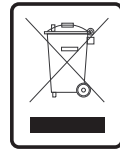
---



**Figure 1-4. OBIS FP with and without Fiber Shutter Cap**

**Waste Electrical and Electronic Equipment (WEEE, 2002)**

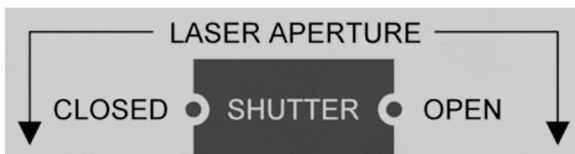
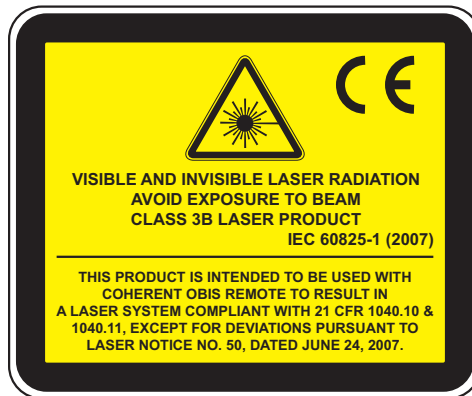
The European Waste Electrical and Electronic Equipment (WEEE) Directive (2002/96/EC) is represented by a crossed-out garbage container label. The purpose of this directive is to minimize the disposal of WEEE as unsorted municipal waste and to facilitate its separate collection. This crossed-out garbage container label is affixed to the cover of the OBIS laser head.



**Figure 1-5. Waste Electrical and Electronic Equipment Label**

## Location of Safety Labels

Refer to the following figure for the location of CDRH compliance labels.



OBIS



OBIS FP

Figure 1-6. Safety Labels (Sheet 1 of 2)

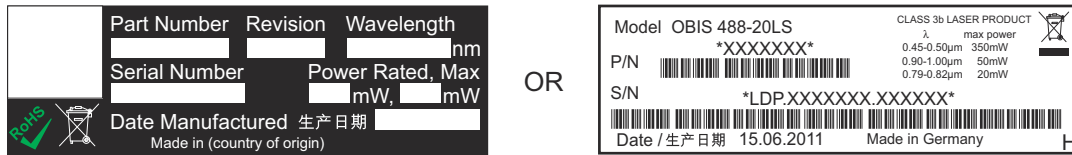



Figure 1-6. Safety Labels (Sheet 2 of 2)

### RoHS Compliance

To comply with the China RoHS (Restriction of Hazardous Substances) Directive effective March 1, 2007, a table of hazardous substances is included in this manual showing which of the offending substances is present in the OBIS laser system.

### Made in (country of origin)

LABEL# 1127166AB	铅	汞	镉	六价铬	多溴联苯	多溴联苯醚	 
	Pb	Hg	Cd	Cr6 <sup>+</sup>	PBB	PBDE	
	X	O	O	O	O	O	

O=小于最高浓度值 X=大于最高浓度值

Figure 1-7. China RoHS Table of Restricted Hazardous Substances

The table in Figure 1-7, above, shows that Lead (Pb) is present in the OBIS laser system (due to the use of brass material) and that the environmental-friendly use period is 20 years as indicated by the 20 inside the circle.

Also, the China RoHS directive requires that the date of manufacture (in Chinese characters) for the OBIS laser system be shown on the product. This is accomplished on the conforming/nonconforming label. Refer to the following figure.

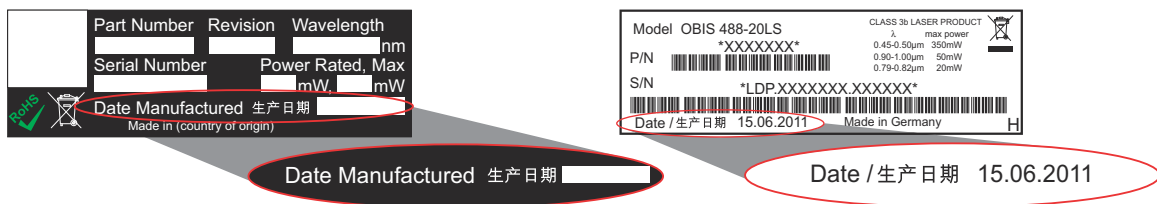


Figure 1-8. China RoHS Date of Manufacture

# FRENCH TRANSLATION/TRADUCTION FRANÇAISE

## PREMIÈRE SECTION : SÉCURITÉ LASER

### Sécurité Optique

La lumière laser, du fait de ses propriétés particulières, ne présente pas les mêmes risques que les autres sources lumineuses traditionnelles. L'utilisation de laser en toute sécurité exige que tout utilisateur de laser, ainsi que toute personne approchant un système laser, connaisse les dangers inhérents à l'utilisation d'une telle source lumineuse. L'utilisation sécurisée de laser dépend de l'habitude qu'a l'utilisateur des instruments et des propriétés d'une lumière cohérente et intense.




---

#### **DANGER !**

**Le contact direct du faisceau laser avec l'œil peut provoquer des lésions importantes et une possible cécité.**

---

*Table 1-4. Tableau de densité optique (D.O.) des protections oculaires*

Wavelength (nm)	Power (mW)	Div (Typ - mrad)	OD	IEC Classification
375	< 20	0.7	> 1.3	3B
405	< 200	0.8	> 2.1	3B
445	< 50	0.8	> 1.7	3B
473	< 20	0.9	> 1.4	3B
488	< 150	0.9	> 1.8	3B
488 LS	< 20	< 1.2	> 2.2	3B
514 LS	< 20	< 1.2	> 2.2	3B
552 LS	< 20	< 1.2	> 2.2	3B
640	< 150	1.2	> 2.2	3B
660	< 150	1.2	> 2.2	3B
785	< 100	1.4	> 2.3	3B

Les faisceaux laser peuvent enflammer des substances volatiles comme l'alcool, l'essence, l'éther ou d'autres solvants et peuvent endommager des éléments sensibles à la lumière comme les caméras vidéo, les photomultiplicateurs et les photodiodes. Les faisceaux



réfléchis peuvent aussi induire des dommages. Pour toutes ces raisons, il est conseillé à l'utilisateur de suivre les précautions suivantes.

1. Observer toutes les précautions de sécurité stipulées dans le manuel de l'utilisateur.
2. Une attention particulière doit être observée lorsque des solvants sont utilisés dans la même salle que le laser.
3. L'utilisation de laser doit être limitée aux personnes qualifiées et habituées à une utilisation sans risque des lasers et informées de leurs dangers.
4. Ne jamais regarder directement le faisceau laser ou la lumière diffusée par une surface réfléchissante. Ne pas renvoyer la lumière laser vers la source laser.
5. Maintenir le montage expérimental à une faible hauteur pour éviter toute rencontre du faisceau laser avec les yeux.



---

#### **AVERTISSEMENT !**

**Les lunettes de sécurité laser peuvent présenter un risque aussi bien qu'un avantage ; elles protègent les yeux d'une exposition potentiellement dangereuse et elles bloquent la lumière aux longueurs d'onde du laser, ce qui empêche l'opérateur de voir le faisceau laser. Par conséquent, veiller à maintenir une attention particulière, même avec l'utilisation de lunettes de sécurité.**

---

6. Afin d'éviter une exposition accidentelle au faisceau de sortie du laser ou à une de ses réflexions, les utilisateurs du système doivent porter des lunettes de sécurité dont la densité optique est dictée par la longueur d'onde que génère le laser.
7. Utiliser le laser dans une pièce fermée. La lumière laser doit rester collimatée sur une longue distance et peut ainsi présenter un risque si elle n'est pas confinée.
8. Placer des panneaux d'avertissement dans la zone où se trouve le faisceau laser pour avertir les personnes présentes.
9. Avertir tous les utilisateurs de laser de ces précautions. Il est préférable de se servir du laser dans une pièce sous accès contrôlé et limité.
10. Lors du processus d'alignement du laser, ne pas porter de vêtements ou d'objets présentant des surfaces réfléchissantes (par exemple, montre ou bijoux).

## Sécurité Electrique



Le système laser OBIS ne contient pas de tensions dangereuses. Ne pas ouvrir le boîtier de l'appareil. Il ne contient pas de pièces réparables par l'utilisateur. Tous les appareils sont conçus pour fonctionner dans l'état où ils ont été assemblés en usine. Toute ouverture du boîtier entraîne l'annulation de la garantie.

---

### MISE EN GARDE !

**Des charges électrostatiques d'une intensité pouvant atteindre 4000 volts peuvent aisément être accumulées sur le corps humain et peuvent être déchargées rapidement et sans détection. Bien que l'électronique de l'appareil bénéficie de protections d'entrée remarquables, les décharges électrostatiques sont susceptibles d'infliger des dommages permanents aux appareils soumis aux décharges électrostatiques de forte intensité. Pour cette raison, les précautions d'usage contre les décharges électrostatiques sont recommandées afin d'éviter les baisses de performance.**

**Les dommages les plus fréquemment observés sont occasionnés lors du maniement de l'appareil au cours de son installation ou de son utilisation. Prendre les mesures appropriées pour protéger le système des décharges électrostatiques.**

**Des conditions telles que la sécheresse de l'air ambiant et la présence de tapis et moquettes peuvent accentuer les risques d'accumulation de charges électrostatiques. Des précautions particulières ou la mise en place d'un blindage contre les décharges électrostatiques doivent être envisagées lors des démonstrations, salons professionnels ou foires commerciales.**

---

## Lasers et dispositifs de sécurité

### Conformité à la norme CDRH/IEC 60825-1

Lorsqu'elle est utilisée avec son mini-contrôleur, la tête laser OBIS est conforme aux normes de sécurité relatives aux produits laser de classe 1 en matière de rayonnement, établies par le CDRH (Center for Devices and Radiological Health) de la FDA (Food and Drug Administration) des États-Unis (21 CFR 1040.10 et 1040.11, sauf pour ce qui tient aux exceptions relatives à la note sur les lasers n° 50 datée du 26 juillet 2001) et la norme IEC 60825-1. Pour prendre

connaissance d'une liste des numéros d'enregistrement de l'appareil auprès du CDRH, complète à la date de la publication du présent document, veuillez ouvrir *141037 rAA - OBIS CDRH Accession Numbers.pdf* sur la clef USB livrée avec votre produit. Pour prendre connaissance de la liste de numéros d'enregistrement la plus récente, veuillez consulter l'adresse: <http://www.coherent.com/Products/index.cfm?1884/OBIS-Lasers>.

En plus de leur conformité aux normes CDRH et IEC 60825-1, la famille des produits OBIS a reçu une homologation décernée par un laboratoire indépendant et a été déclarée conforme aux directives environnementales et sécuritaires dont la liste suit.

**EMI Standard for Emissions per:**

*EN55011:2007*

Class A Radiated Emissions

*EN55011:2007*

Class A Conducted Emissions

*EN61000-3-2:2006*

Power Line Harmonics

*EN61000-3-3:1995:A1:2001:A2:2005*

Power Line Voltage Fluctuation and Flicker

**EMC Standard for Immunity per:**

*EN61000-4-2:2003*

Electrostatic Discharge – Performance Criteria B

*EN61000-4-3:2006*

Radiated Immunity – Performance Criteria A

*EN61000-4-4:2004*

Electrical Fast Transient Immunity – Performance Criteria B

*EN61000-4-5:2004*

Electrical Slow Transient Immunity – Performance Criteria B

*EN61000-4-6:2003*

Conducted RF Immunity – Performance Criteria A

*EN61000-4-11:2004*

Power Line Interruptions, Dips, and Dropouts – Performance  
Criteria B

**Low Voltage Directive 73/23/EEC Tests per:**

*EN61010-1:2001*

Safety Requirements Part 1: General Requirements

**MD – Machinery Directive for Laser Devices Tests per:**

*EN60825-1:2001*

Safety of Laser Products – Part 1: Equipment Classification  
Requirement and User's Guide

*EN60825-2:2005*

Safety of Laser Products – Part 2: Safety of Optical Fiber  
Communication Systems

*EN60825-12:2004*

Safety of Laser Products – Part 12: Safety of Free Space Optical  
Communication Systems Used for Transmission of Information

*21CFR 1040.10*

Déclaration de-  
conformité—OBIS  
LX

D141153

Revision AA

## Declaration of Conformity

We

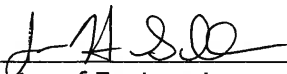
Coherent, Inc.  
27650 SW 95<sup>th</sup> Ave  
Wilsonville, Oregon, USA 97070

declare under sole responsibility that the

**OBIS Laser Family**

meets the intent of Directives 2004/108/EC for Electromagnetic Compatibility and 2006/95/EEC for Product Safety for Measurement, Control and Laboratory Equipment including the following test specifications:

- EN55011:2007 Class A Radiated Emissions
- EN55011:2007 Class A Conducted Emissions
- EN61000-3-2:2006 Powerline Harmonics
- EN61000-3-3:1995:A1:2001:A2:2005 Powerline Voltage Fluctuation and Flicker
- EN61000-4-2:2003 Electrostatic Discharge – Performance Criteria B
- EN61000-4-3:2006 Radiated Immunity – Performance Criteria A
- EN61000-4-4:2004 Electrical Fast Transient Immunity - Performance Criteria B
- EN61000-4-5:2005 Electrical Slow Transient Immunity- Performance Criteria B
- EN61000-4-6:2006 Conducted RF Immunity - Performance Criteria A
- EN61000-4-11:2004 Power Line Interruptions, Dips, and Dropouts - Performance Criteria B
- EN61010-1:2001 Safety Requirements Part 1: General Requirements
- EN60825-1:2007 Safety of Laser Products – Part 1: Equipment Classification Requirement and User's Guide
- EN60825-2:2005 Safety of Laser Products – Part 2: Safety of Optical Fiber Communication Systems
- EN60825-12:2004 Safety of Laser Products – Part 12: Safety of Free Space Optical Communication Systems Used for Transmission of Information

  
\_\_\_\_\_  
Director of Engineering

Date: 1/31/11

  
\_\_\_\_\_  
Vice President, LSM

Date: 1/31/11

Coherent, Inc.

# Déclaration de- conformité—OBIS LS

## EG-Konformitätserklärung

Für das folgend bezeichnete Erzeugnis

## EC Declaration of Conformity

For the following named product

### Coherent OBIS LS

bestehend aus Laserkopf und Netzteil, wird hiermit bestätigt, dass es den grundlegenden Anforderungen entspricht, die in der Richtlinie des Rates zur Angleichung der Rechtsvorschriften der Mitgliedsstaaten über die elektromagnetische Verträglichkeit (2004/108/EG), sowie der Niederspannungsrichtlinie (2006/95/EG) festgelegt sind.

Das o.g. Erzeugnis ist zur Erfüllung der Anforderungen gemäß EN 60825-1:2007 ausgerüstet. Die tatsächliche Erfüllung der EN 60825-1:2007 obliegt dem Integrator.

Diese Erklärung bezieht sich auf alle Exemplare, die dem Fertigungsstand ab dem folgenden Datum entsprechen:

consisting of laser head and power supply, we declare that it complies with the basic requirements defined in the EC Directive on the harmonization of the laws of member states relating to electromagnetic compatibility (2004/108/EG) and the low voltage directive (2006/95/EG).

The above mentioned product is equipped to comply with EN 60825-1:2007. The actual compliance to EN 60825-1:2007 is the obligation of the integrator.

This declaration pertains to all products which are manufactured according to the manufacturing procedures valid on:

Sept. 13th 2011

Zur Beurteilung des Erzeugnisses hinsichtlich elektromagnetischer Verträglichkeit wurden folgende Normen herangezogen

EN 55022, Kl.B (05.08),  
EN 61000-4-2 (12.09),  
EN 61000-4-3 (06.08),  
EN 61000-4-4 (07.05),  
EN 61000-4-5 (06.07),  
EN 61000-4-6 (12.09)

The following standards were used to assess the product concerning electromagnetic compatibility

EN 55022, Kl.B (05.08),  
EN 61000-4-2 (12.09),  
EN 61000-4-3 (06.08),  
EN 61000-4-4 (07.05),  
EN 61000-4-5 (06.07),  
EN 61000-4-6 (12.09)

Zur Beurteilung des Erzeugnisses hinsichtlich der Niederspannungsrichtlinie wurden folgende Normen herangezogen :

EN 61010-1: 2001

Diese Erklärung wird verantwortlich für den Hersteller

The following standards were used to assess the product concerning low voltage compatibility:

EN 61010-1 : 2001

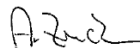
This declaration is given in account for the manufacturer

Coherent GmbH  
Niederlassung / Branch Luebeck  
Seelandstraße 9  
23569 Lübeck, Germany

abgegeben durch  
Andreas Zuck, Produktmanager

by  
Andreas Zuck, Product Line Manager

Lübeck, Sept. 13th 2011



**Limites d'émission  
et classification  
laser**

Le système laser OBIS a été déclaré appartenir à la Classe IIIb par le CDRH (Center for Devices and Radiological Health) des États-Unis. Il est susceptible d'émettre des RAYONNEMENTS LASER VISIBLES ou INVISIBLES sur les longueurs d'onde de 0,3 à 1,0 m de distance de l'ouverture située devant la tête laser.

**Boîtier protecteur**

Le rayonnement laser est entièrement confiné dans un boîtier métallique protecteur, sauf pour ce qui est de l'ouverture ménagée pour le rayon laser. Le boîtier protecteur ne doit jamais être ouvert.

**Verrouillage à  
distance**

Le mini-contrôleur est muni d'un circuit de verrouillage à distance qui empêche la production de rayonnement laser lorsque ce circuit est ouvert. Ce circuit de verrouillage est muni de sécurités intégrées de façon redondante. La Figure 1-9 (p. 1-24) montre un diagramme de la configuration du circuit de verrouillage à distance. Le connecteur de verrouillage est situé sur le mini-contrôleur et peut être utilisé avec les systèmes LS et LX.

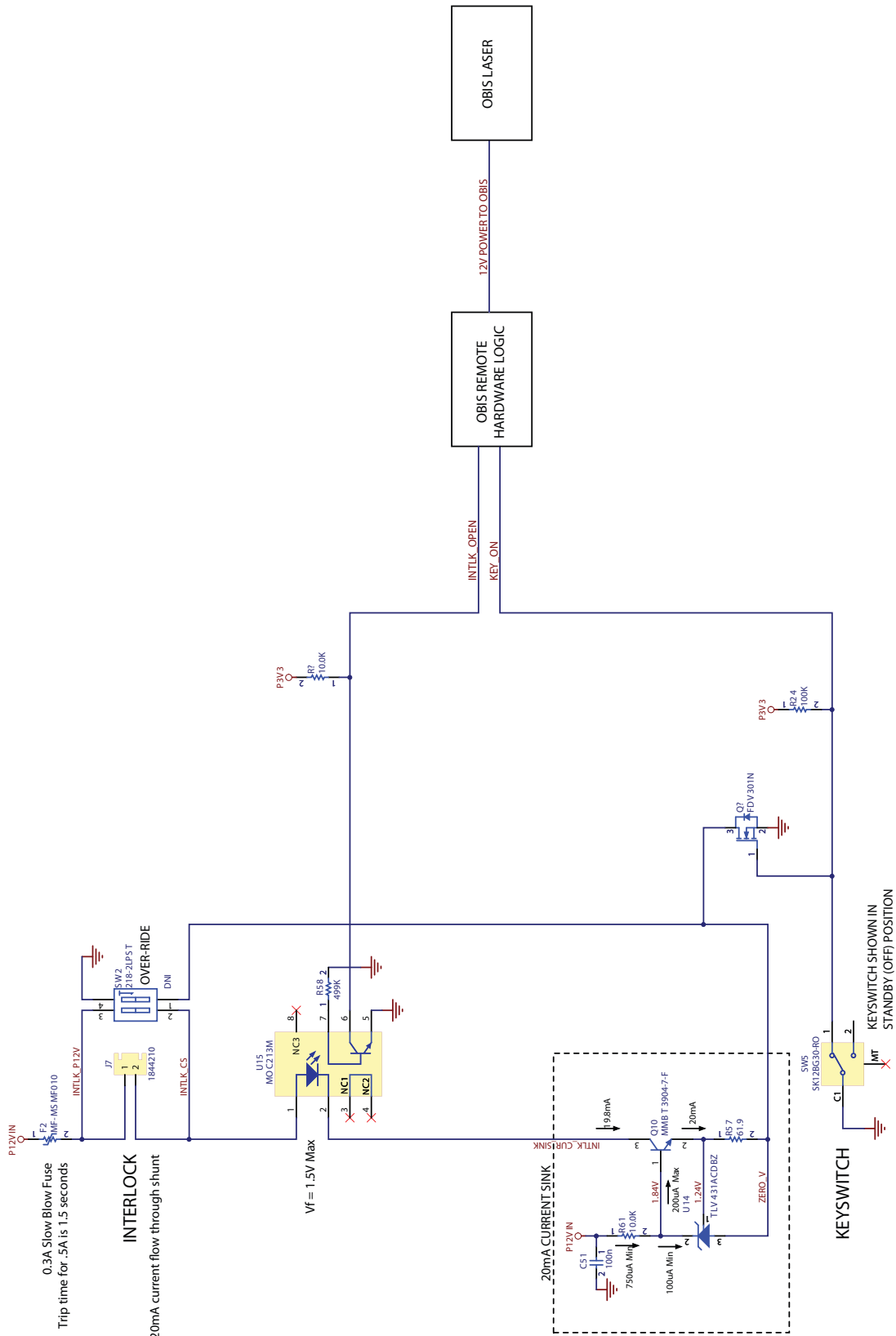
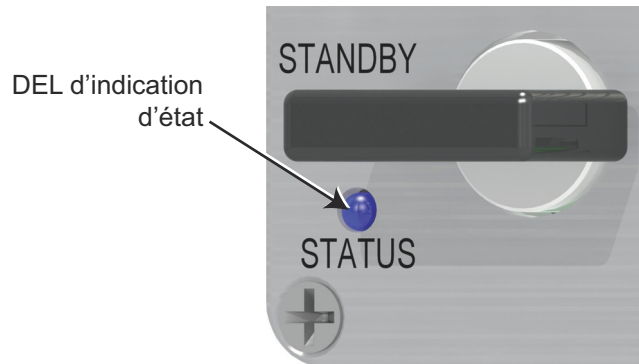


Figure 1-9. Diagramme du circuit de verrouillage et du commutateur à clef



## Interrupteur à clef

La commande à distance OBIS est équipée d'un commutateur à clef empêchant l'émission de radiation laser lorsqu'il est placé dans la position STANDBY (mise en veille). La radiation laser peut être émise lorsque la clef est placée dans la position ON (marche). La clef peut être retirée lorsqu'elle se trouve en position STANDBY ; elle ne le peut lorsqu'elle est mise en position ON.



**Figure 1-10. L'interrupteur à clef pour commande à distance OBIS**

Le fonctionnement de l'interrupteur à clef assure la même fonction que la réinitialisation manuelle CDRH : après une erreur du mécanisme d'interdiction ou une interruption de la tension, le laser ne redémarre pas automatiquement, à moins que l'interrupteur à clef n'ait été 1) remis en position STANDBY, puis 2) replacé en position ON. La figure 1-1 (p. 1-9) contient les informations relatives au circuit de l'interrupteur à clef.

La diode indicatrice d'état du panneau avant s'allume en vert, bleu ou rouge, reflétant le réglage fait sur la commande à distance OBIS. *Pour plus d'informations concernant la DEL d'état de la commande à distance de la commande à distance OBIS 6-Laser, veuillez vous reporter à la section " Status LED Indicator " (p. 2-7).*

Le tableau ci-dessous est le tableau de vérité de la DEL indicatrice d'état de la commande à distance OBIS.

**Table 1-5. États de la DEL de la commande à distance OBIS**

Mode	LED Status	Internal Auto Start Jumper	Key Switch Position	Interlock Status
1	Bleue	Retiré	STANDBY	X
2	Clignote en bleu	Retiré	En marche lors de la mise sous tension	X
3	Verte	Retiré	Passe de STANDBY à ON	Fermé
4	Bleue	Présent	STANDBY	X
5	Verte	Présent	ON	Fermé
6	Rouge	X	ON	Ouvert

Pour plus de détails, se reporter au Tableau 2-11 (p. 2-28).



---

**AVERTISSEMENT !**

**Lorsque l'interrupteur à clef est en position ON, le plot de verrouillage est connecté et les interrupteurs du laser sont en position ON et allumés : l'émission laser est possible.**

---

**Indicateurs  
d'émission de  
laser**

Le mini-contrôleur du système comporte un indicateur d'émission laser, situé sur le panneau avant. Lorsque le voyant DEL indicateur n'est pas allumé, la présence de rayonnement laser n'est pas possible. Lorsque le voyant est allumé, le laser doit être considéré comme dangereux ; un faisceau laser peut être produit à tout moment (par exemple par l'intermédiaire d'une commande informatique). Après l'allumage du voyant DEL blanc, un délai est ménagé avant l'émission effective d'un rayonnement laser, ce qui permet à l'opérateur de prendre les mesures appropriées pour éviter l'exposition au faisceau laser. Ce délai d'attente est d'au moins cinq secondes.

**Exposition aux  
rayonnements**

L'utilisation de commandes, de réglages ou l'exécution de procédures autres que celles spécifiées dans ce manuel peuvent entraîner l'exposition à des rayonnements dangereux.

## Mécanisme d'obturation

Le laser comporte un obturateur à commande manuelle situé au niveau d'ouverture destinée au faisceau laser, devant la tête laser. Lorsque l'obturateur est totalement clos, aucun rayonnement laser n'est émis.

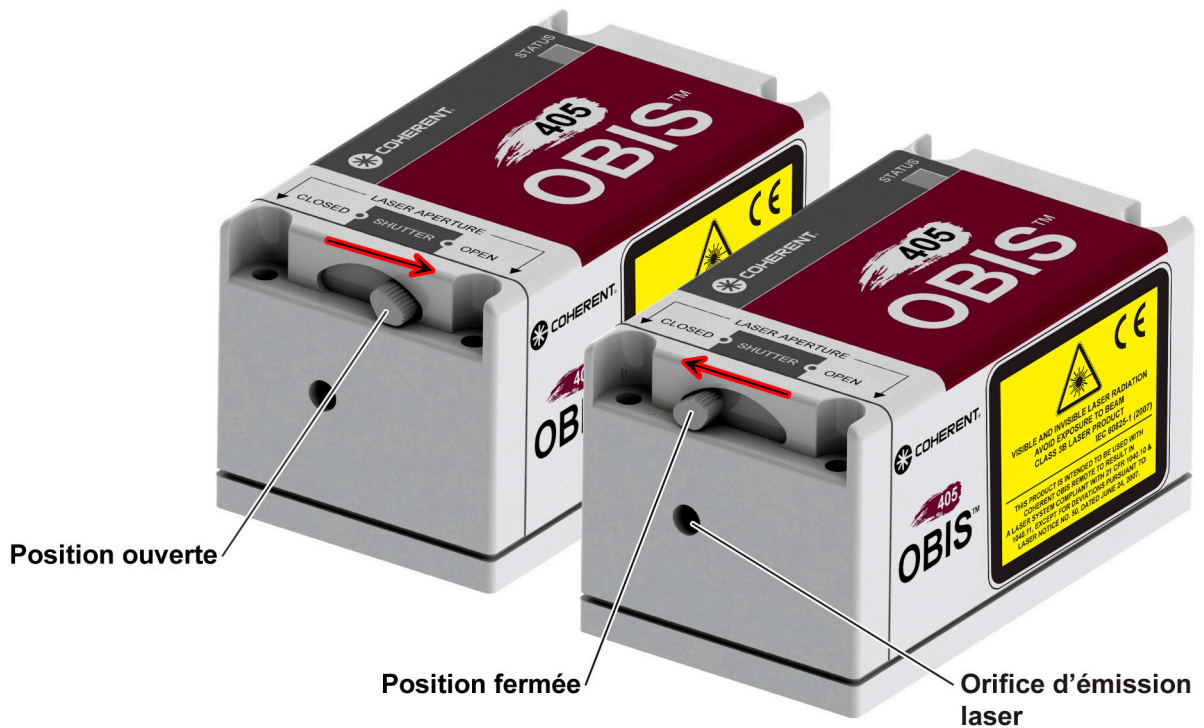


Figure 1-11. Commande manuelle de l'obturateur en positions ouverte et fermée

## Waste Electrical and Electronic Equipment (WEEE, 2002)

La directive européenne « Waste Electrical and Electronic Equipment » (WEEE) (2002/96/CE) est symbolisée par l'image d'une poubelle barrée. Le but de cette directive est de minimiser l'impact des déchets d'équipements électriques et électroniques sur l'environnement et de faciliter la mise au rebut appropriée de ces produits. L'étiquette portant le symbole de la poubelle barrée est apposée sur le boîtier de la tête du laser OBIS.

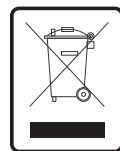
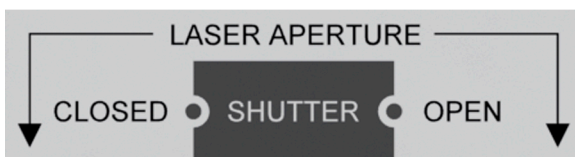


Figure 1-12. Étiquette portant le symbole de la directive « Waste Electrical and Electronic Equipment »

**Emplacement des étiquettes de sécurité**

Se référer à la Figure 1-13 pour l'emplacement des étiquettes de sécurité.



OBIS



OBIS FP

**Figure 1-13. Etiquettes de Sécurité (Sheet 1 of 2)**

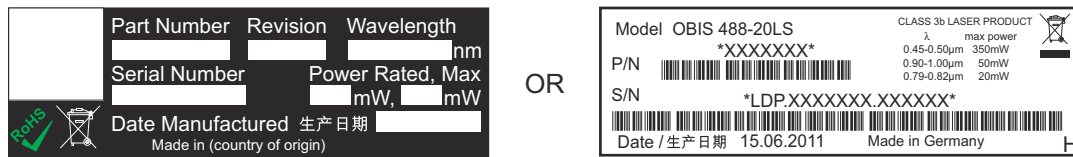


Figure 1-13. Etiquettes de Sécurité (Sheet 2 of 2)

### Conformité au RoHS

Pour se conformer à la directive chinoise RoHS (Restriction of Hazardous Substances), entrée en vigueur le 1er mars 2007, un tableau énumérant les substances dangereuses est inclus dans ce manuel. Il indique celles des substances irrégulières citées par cette directive sont présentes dans le système laser OBIS.

Made in (country of origin)

LABEL# 1127166AB	铅	汞	镉	六价铬	多溴联苯	多溴联苯醚	
	Pb	Hg	Cd	Cr6 <sup>+</sup>	PBB	PBDE	
	X	O	O	O	O	O	

O=小于 最高浓度值 X=大于 最高浓度值

Figure 1-14. Tableau conforme à la directive chinoise RoHS indiquant les substances dangereuses soumises à des restrictions

Le tableau de la Figure 1-14, ci-dessus, indique la présence de plomb (Pb) dans le système laser OBIS (elle est due à l'utilisation de laiton dans l'appareil) et que sa période d'utilisation sans risques pour l'environnement est de vingt ans, comme indiqué par le nombre 20 entouré d'un cercle.

La directive chinoise RoHS requiert également que la date de fabrication du système laser OBIS soit apposée sur le produit (en caractères chinois). Ceci est fait sur l'étiquette conforme/non conforme. Prière de se référer à l'illustration suivante.

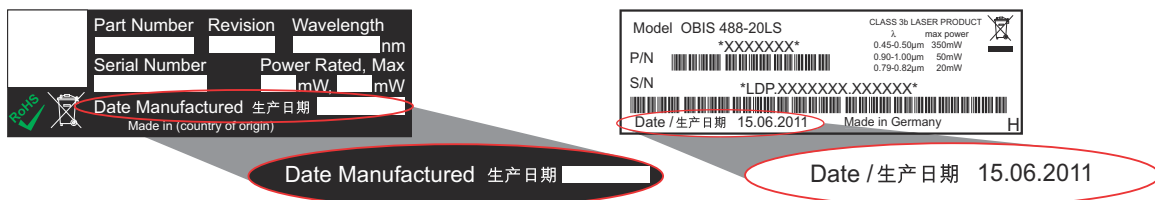


Figure 1-15. Date de fabrication pour la directive chinoise RoHS



## SECTION TWO: DESCRIPTION AND SPECIFICATIONS

In this section:

- System description (p. 2-2)
- Laser head (p. 2-3)
- Optional heat sink (p. 2-11)
- Power supply for OBIS Laser or OBIS Remote (p. 2-12)
- OBIS Remote (p. 2-13)
- OBIS 6-Laser Remote (p. 2-25)
- Humidity (p. 2-33)
- Dimensions (p. 2-34)



*Figure 2-1. OBIS Laser System Components and Accessories*

## System Description

The OBIS laser system combines the very latest semiconductor laser technology with proven high-quality diode laser system manufacturing techniques. This laser system is the most advanced compact full-feature laser system on the market today.

The OBIS laser system—Figure 2-1 (p. 2-1)—is a complete system with laser head, OBIS Remote or OBIS 6-Laser Remote, power supply, and interface cables and can be mounted to a plate with the appropriate heat sink capability. This system delivers power, stability, and performance in a small package and at an attractive price. The OBIS laser system can operate in Pulse or CW mode, and includes complete remote communication and control via RS-232 or USB connection.

The OBIS Remote, when properly installed and operated, allows for the Class IIIb (CDRH)/Class 3B (IEC) laser system to conform to the CDRH 21 CFR 1040 and IEC 60825-1 requirements for a “conforming” system. The system is tested and certified at the factory to ensure that all of the safety features are operational. Bypassing or otherwise disabling these safety features will invalidate the conformity to the CDRH and IEC regulations.

The optional heat sink accessory provides a solid foundation for cooling to a maximum ambient temperature of 40°C. The solid heat sink foundation is designed to maintain the specified system pointing stability. The heat sink includes a fan that connects directly to the fan port on the laser head. English and metric mounting hardware is also included.

## Features

- Single transverse mode
- (*LX systems only*) Thermoelectrically-cooled for extended life and improved stability
- Compact package
- High-quality glass optics
- Maximum digital modulation control:
  - 150 MHz (LX version)
  - 0.05 MHz (LS version)
- Maximum analog modulation control:
  - 1 MHz (LX version)
  - 0.1 MHz (LS version)]
- Circular beams
- RS-232 and USB remote communication



- OBIS software
- Mechanical beam shutter
- OBIS Remote for regulatory compliance (optional)
- Heat sink (optional)

## Laser Head

The laser head is the base module for the OBIS laser system and can be used either as a stand-alone, or in conjunction with an OBIS Remote or OBIS 6-Laser Remote.



---

**NOTICE!**

**The shutter for the OBIS is included in the head. The shutter for the OBIS FP is the fiber end cap.**

---



---

**NOTICE!**

**To be CDRH compliant, you *must* use an OBIS Remote with the laser head—the laser head alone is *not* CDRH compliant.**

---

- **For CDRH-compliant installation and operation, only the SDR connection to the OBIS Remote is required.** The USB and power supply connections on the laser head are ineffective when the OBIS Remote is connected.
- It is possible to operate the laser head without the OBIS Remote; ***doing so, however, renders this type of operation as non-CDRH compliant.*** The user assumes all responsibility for safety and proper compliance to CDRH 21 DFR 1040 and IEC60825-1. For details, refer to “Installing and Operating the OEM Laser Head Only” (p. 6-4).

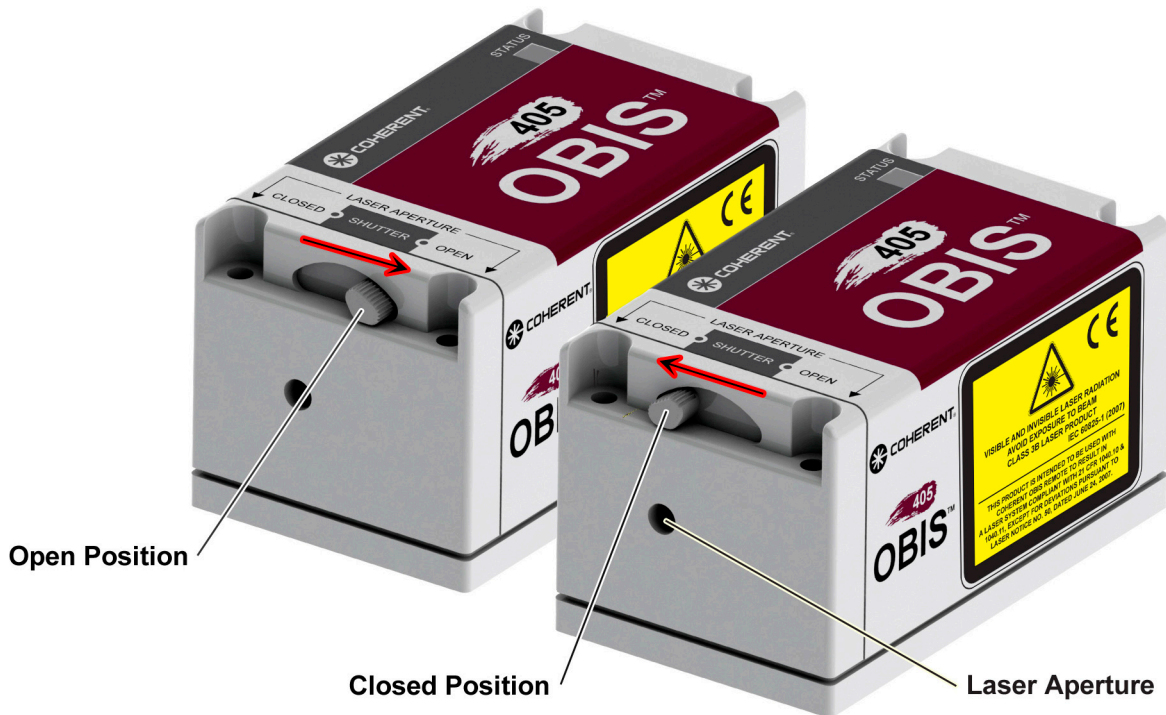
## Front Panel

The laser head front panel (Figure 2-2) includes the laser beam aperture and the shutter control.



**Figure 2-2. Laser Head Front Panel**

The following figure shows the shutter control in the Open and Closed positions.



**Figure 2-3. Shutter Control: Open and Closed Positions**

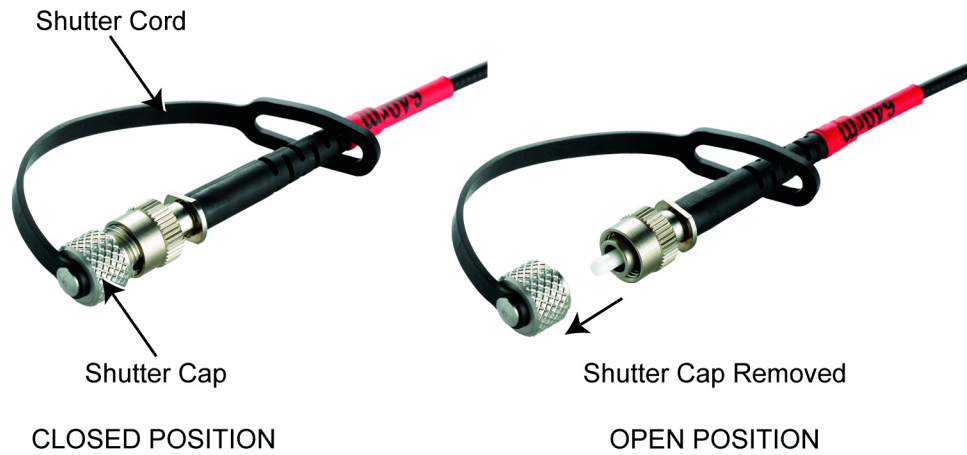


Figure 2-4. OBIS FP Shutter Control: Open and Closed Positions

### Back Panel

Indicators and connectors on the laser head back panel are shown in the following figure.

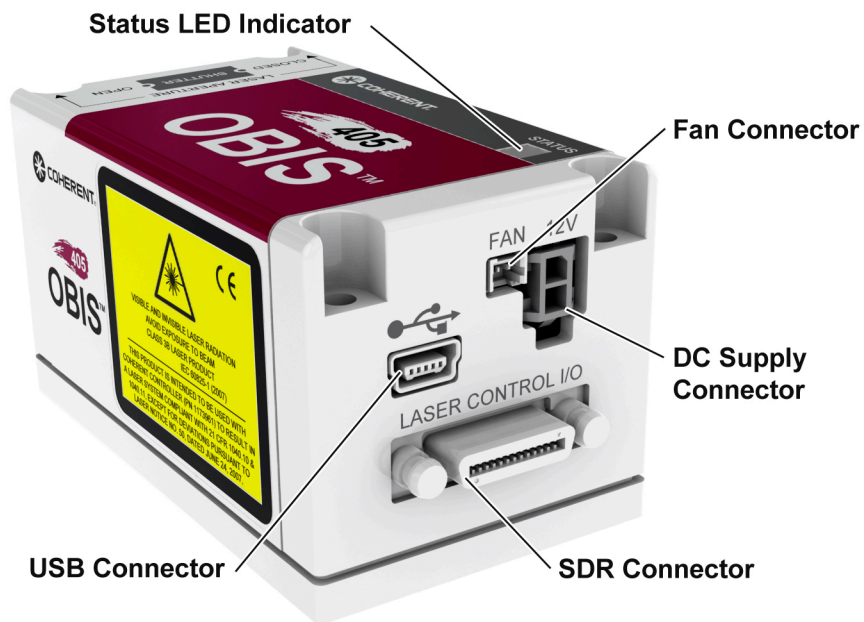
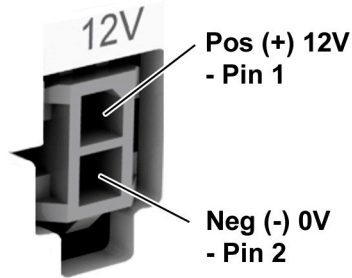


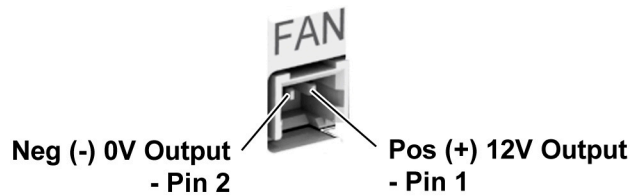
Figure 2-5. Laser Head Back Panel

**DC Supply Connector** The DC Supply connector connects the laser head to the power supply, if the DC power is not provided through the SDR connector. Type: Molex Micro-Fit, part no. 43045-0200. To connect to this connector, use Molex SDA43025-0200 with pins 43031-009.



*Figure 2-6. DC Supply Connector Pin Location*

**Fan Connector** The fan connector provides a 12V outlet to supply a fan that cools the heat sink of the laser head. Type: Molex Picoblade 52048-0210.



*Figure 2-7. Fan Connector Pin Location*

**SDR Connector** Use this connector to connect an SDR cable between the laser head and the OBIS Remote. Type: 3M 12226-1150-00FR.



*Figure 2-8. SDR Connector*

**USB Connector**

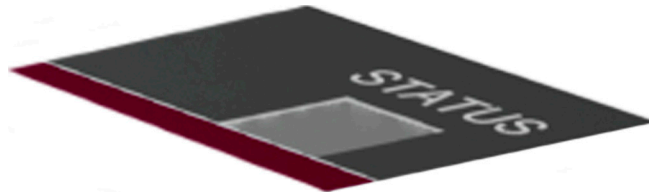
This is a standard Mini-B connector, which is used to establish connection to a PC for remote control of the laser.



*Figure 2-9. USB Connector*

**Status LED Indicator**

This tri-color LED indicates the actual status of the laser. Refer to Table 2-2 (p. 2-10) for a description of the laser colors and blink codes.



*Figure 2-10. Status LED Indicator*

**System Diagram**

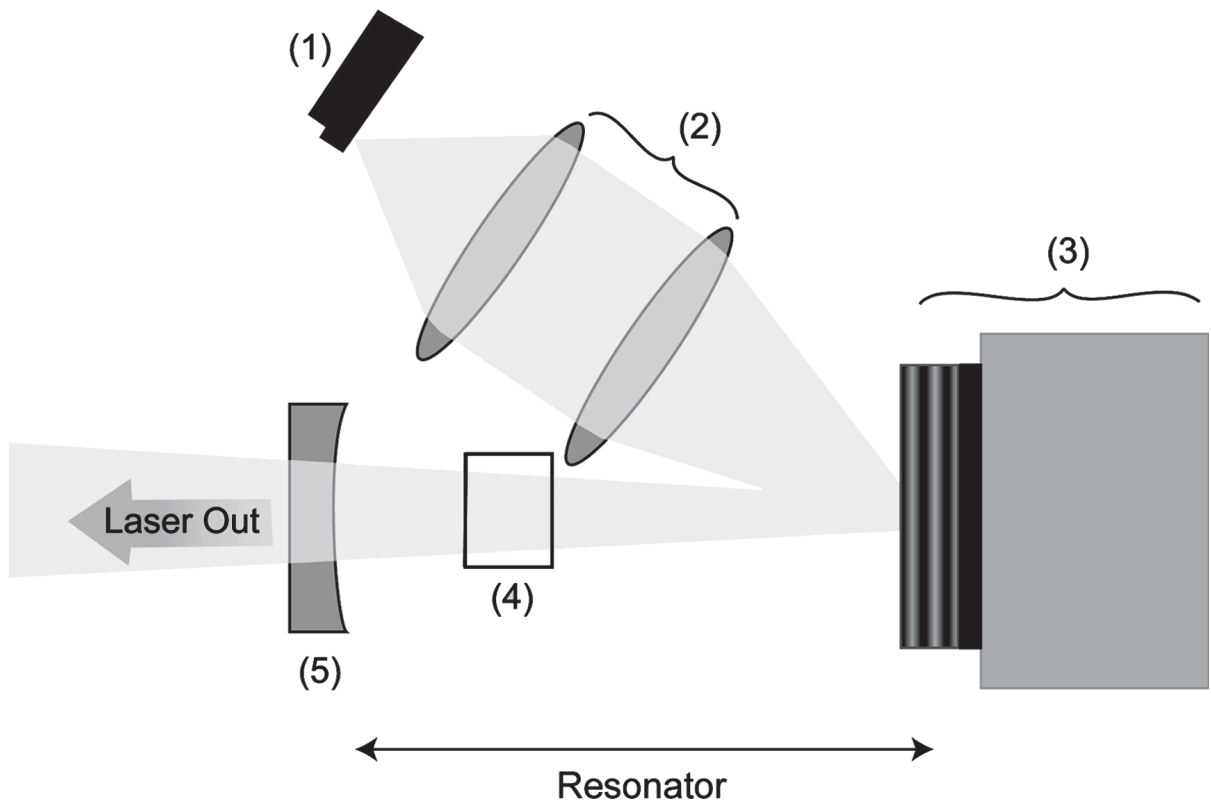
The OBIS direct diode system uses an output beam directly emitted from a semiconductor laser. The output beam of the diode is first collimated by a high-aperture lens and then circularized to a round shape. A pickoff window sends a small portion of the laser power to a photodiode, whose signal is used for the feedback loop to stabilize the laser power. A thermoelectric cooler (TEC) and temperature sensors are used for stabilizing the temperature of the optical housing. Excess heat is dissipated through the base plate of the laser head. The laser head is connected to the OBIS Remote by a SDR cable. The system is schematically illustrated by the block diagram shown in the following figure.

**Configurations**            The following table lists all possible laser head configurations.

**Table 2-1. Laser Head Configurations**

<b>Base Device</b>	<b>Connections</b>	<b>Communication Priority</b>	<b>Operational Comments</b>
Laser Head	SDR only	SDR	The SDR connector is used for power in and all commands.
	USB only	N/A	The laser head cannot function in this mode because no power is available.
	Power only	N/A	Initiates the Auto-Start function.
	SDR and USB	SDR	The SDR connector supplies power and takes communication priority.
	SDR and Power	SDR	The SDR connector supplies power and takes communication priority. <b><i>When SDR and external power are both in use, the highest voltage source “wins.” This defeats the hardware laser power interlock on the OBIS Remote.</i></b>
	USB and Power	USB	The USB connector provides communication functions and Power provides power to the laser head.

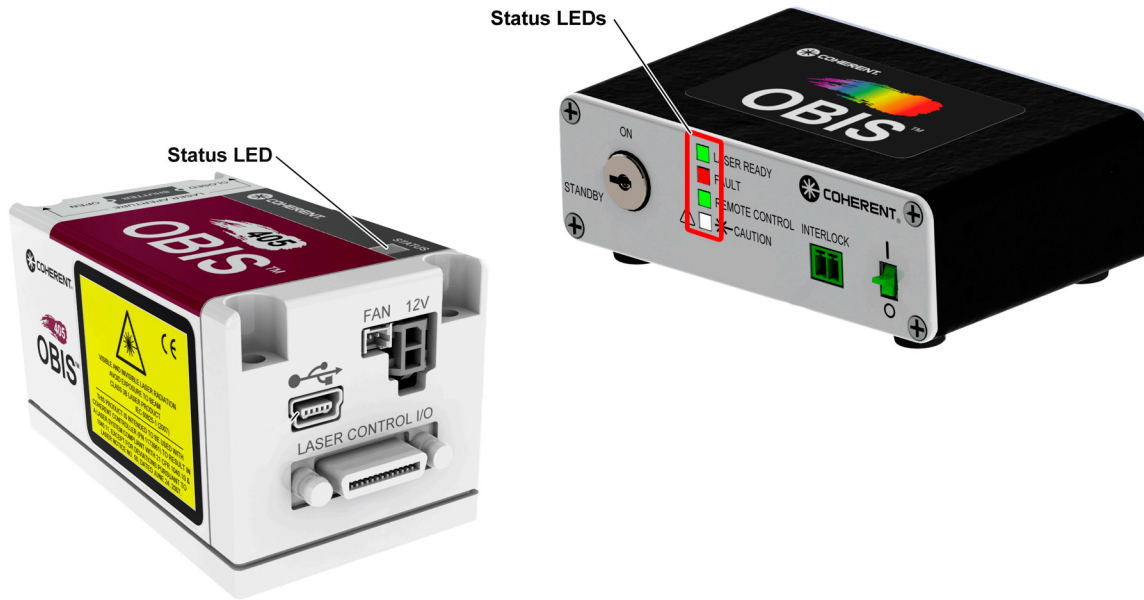
Figure 2-11 shows the optical schematic.



1. Pump diode
2. Focusing optic
3. OPS chip
4. Doubling crystal
5. Output coupler

**Figure 2-11. Optical Schematic (LS laser only)**

## OBIS Remote Status LED States



**Figure 2-12. Status LED Locations**

Table 2-2, below, lists all the possible states of the LEDs for the laser head, OBIS Remote, and OBIS Connection software. For a list of OBSI 6-Laser Remote LED states, refer to Table 2-11 (p. 2-28).

**Table 2-2. OBIS Remote Status LED States**

Laser Status	Status Tri-color Led on Laser Head	LEDs on OBIS Remote Front Panel				Interlock LED <sup>a</sup>
		Laser Ready	Fault	Remote Control	Caution	
Hard Fault <sup>b</sup>	Red	OFF	Red	ON only when USB/RS-232 connected; otherwise, OFF	OFF	OFF
Warm-up	Flashing green at 2.5 Hz	Flashing green at 2.5 Hz	OFF		OFF	OFF
Standby	Blue	OFF	OFF		OFF	OFF
CDRH 5-sec. Delay	White	Flashing green at 2.5 Hz	OFF		ON	ON
Laser Emission but not Ready <sup>c</sup>	White	Flashing green at 2.5 Hz	OFF		ON	ON
Laser Ready <sup>d</sup>	White	ON	OFF		ON	ON

a. The user has the option of connecting an external LED in series to the interlock (12V, 20 mA). This optional LED accessory is available from Coherent—refer to Table B-1 (p. B-1) for ordering information.

b. Detailed information regarding hard faults is listed in Table 7-4 (p. 7-13).

c. This means either: (1) the laser is in constant-power mode but power has not reached Pset value; or (2) the laser is in non-constant-power mode (that is, in either constant-current mode or external modulation mode).

d. “Laser Ready” means that the laser operates in constant-power mode and power has reached the Pset value.

## Specifications

For current laser head specifications, refer to the OBIS data sheet.



## Optional Heat Sink



*Figure 2-13. Optional Heat Sink*

An optional heat sink is available if heat sinking of the laser head is not covered by the OEM integration. For installation instructions, refer to “Installing the Optional Heat Sink” (p. 3-2).

## Features

- Small footprint
- Rugged design
- Precision dowel pin laser positioning
- Convenient 69 mm (2.7 in.) beam height
- Integrated cooling fan with vibration isolation
- Output beam centered on standard table bolt pattern
- Universal mounting to imperial or metric bolt pattern
- Proven stable performance over time and temperature
- Fan power connector plugs directly to OBIS laser head
- Laser can be mounted on top or side for opposite polarization

## Power Supply for OBIS Laser or OBIS Remote

The OBIS laser system includes a power supply, which has a power ON indicator. **Note: The power supply is not compatible with OBIS 6-Laser Remote.**



*Figure 2-14. Power Supply*

The power supply is a universal AC input with a DC-regulated output. Use only the Coherent-approved power supply that comes standard with every system.



---

**NOTICE!**

**Beware of power supplies that may look similar but have different output voltages that could damage your laser system.**

---

## Specifications

*Table 2-3. Power Supply Specifications*

Description	Specification
Input voltage	100 to 240 VAC
Input current	0.55A
Input frequency	47 to 63 Hz.
Output voltage	12 VDC
Output current	2A
Rated output power	25W (maximum)
Output regulation	± 5%
Line voltage regulation	± 1% typical measured at full load

## OBIS Remote

The OBIS Remote is a small control box that allows you to connect to—and interface with—a single laser head. OBIS Remotes are “stackable,” which permits multiple Remotes to be set up in a single system.




---

**NOTICE!**

**To be CDRH compliant, you *must* use an OBIS Remote with the laser head—the laser head alone is *not* CDRH compliant.**

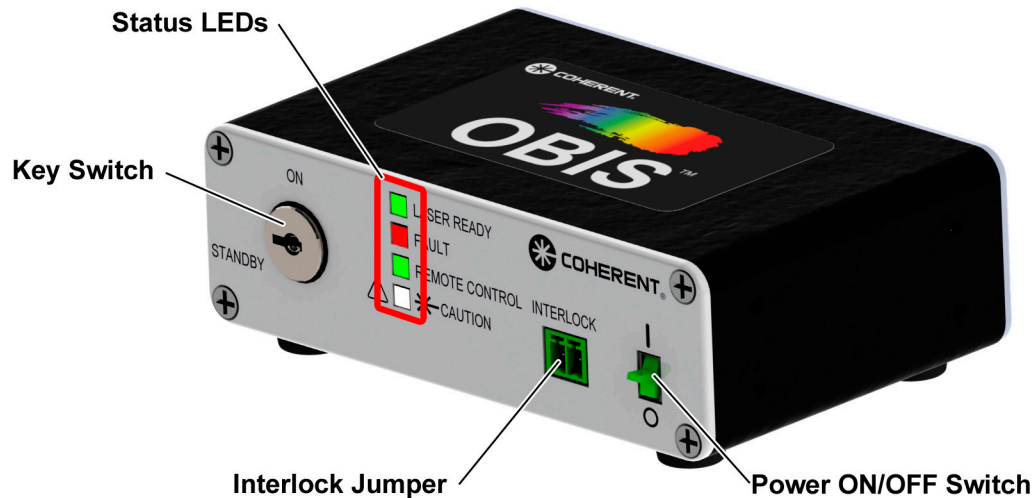
---

The OBIS Remote offers an ON/STANDBY keyswitch, a remote interlock, and an emission indicator. With these safety features, the system is CDRH compliant. If Auto Start equals OFF, there is also a 5-second delay added before laser emission.

The modulation SMB connectors are used for analog or digital modulation or variable power control. Review Analog Modulation specifications for input requirements.

## Front Panel

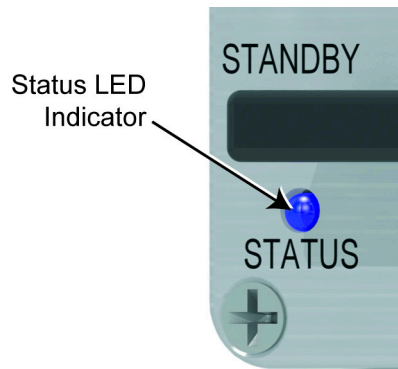
Indicators and connectors on the OBIS Remote front panel are shown in the following figure.



**Figure 2-15. OBIS Remote Front Panel**

## Key Switch

This is a single-key switch master power control for laser emission supply.



**Figure 2-16. OBIS Remote Key Switch**

The following figure shows the key switch in the STANDBY and ON positions.

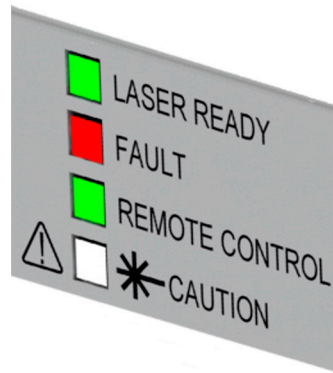


**Figure 2-17. OBIS Remote Key Switch STANDBY and ON Positions**

**Status LED Indicators**

There are four Status LEDs on the front panel (listed top-to-bottom):

- Laser Ready
- Fault
- Remote Control
- Caution (emission indicator)

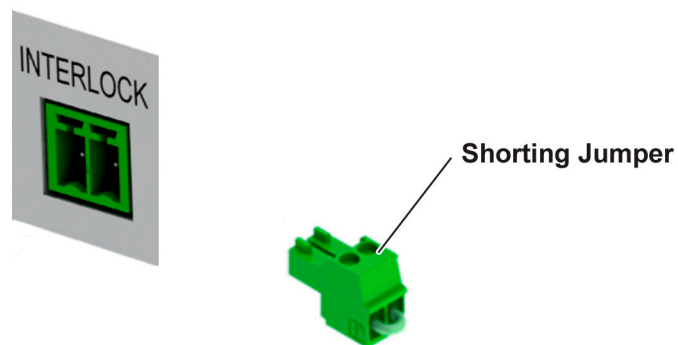


**Figure 2-18. OBIS Remote Status LED indicators**

For a complete list of Status LED states, refer to “OBIS Remote Status LED States” (p. 2-10).

**Interlock Jumper**

This is a mechanical-style jumper for CDRH interlock. The interlock has terminal style connections that allow connection to an external control device.



**Figure 2-19. OBIS Remote Interlock Jumper**

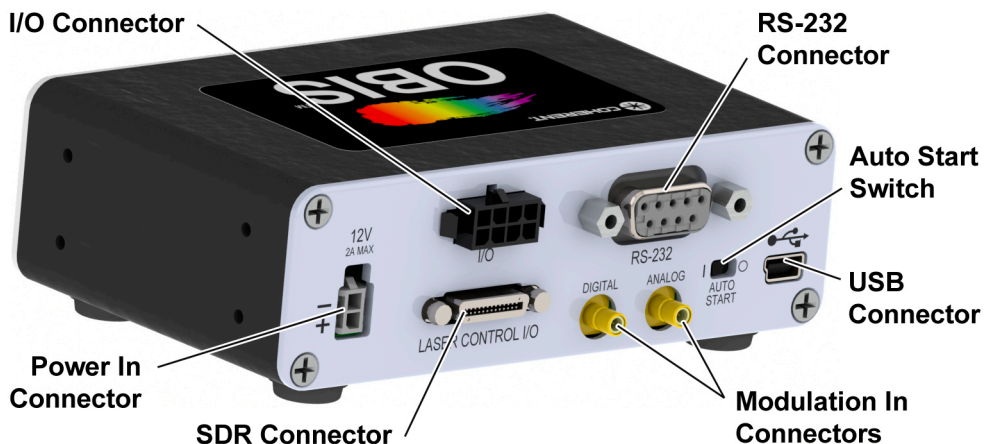
**Power ON/OFF Switch** Applies power to the OBIS Remote. The switch illuminates green when power is applied.



*Figure 2-20. OBIS Remote Power ON/OFF Switch*

### Back Panel

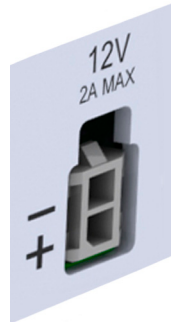
The back panel of the OBIS Remote (Figure 2-21, below) has the following connectors: power in, I/O, laser head, modulation in, RS-232, and USB. The auto start switch is also located on the back panel. These are discussed below.



*Figure 2-21. OBIS Remote Back Panel*

## Power In Connector

Power is supplied to the OBIS Remote through a 5.5 mm, 2-pin, male, Molex connector (P/N SDA40325-0200, contact pin 43031-0009). The OBIS Remote, in turn, supplies power to the laser head through the SDR connector.



**Figure 2-22. OBIS Remote Power In Connector**

- The SDR connector and the power connector on the laser head *should not be connected at the same time*; however, doing so will not damage the system.
- The highest voltage wins since power is “diode OR'ed.” This defeats the OBIS Remote interlocks.

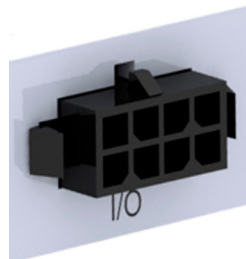
Coherent provides the power supply for the OBIS Remote—for more information about the power supply, refer to “Power Supply for OBIS Laser or OBIS Remote” (p. 2-12).

## I/O Connector

This is an 8-pin header connector. Connector type at OBIS Remote: Molex Micro Fit 43020-0800. Needed connector for cable: Molex Micro Fit 43025-0800

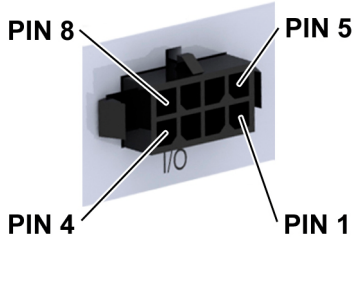
Signals:

- Laser Fault
- Laser Ready
- Base plate temperature
- Power monitor
- Slow digital modulation
- Laser diode current
- Ground connection (x2)



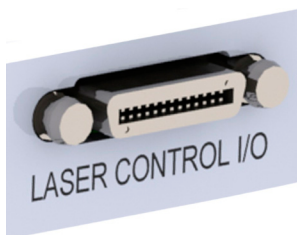
**Figure 2-23. OBIS Remote I/O Connector**

**Table 2-4. I/O Connector Pinout Specifications**

Signal Name	Pin Number	Direction	Pin Locations
Laser Fault	1	Analog out	
Laser Ready	2	Analog out	
Base Plate Temperature	3	Analog out	
Power Monitor	4	Analog Out	
Slow Digital Modulation	5	Digital in	
Laser Diode Current	6	Analog Out	
Ground Connection	7	GND	
Ground Connection	8	GND	

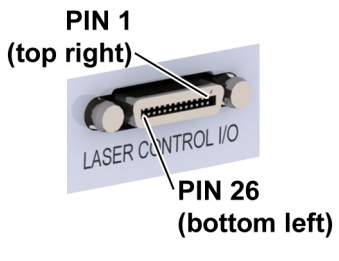
**SDR Connector**

Use this connector to connect an SDR cable between the OBIS Remote and the laser head.



**Figure 2-24. OBIS Remote SDR Connector**

**Table 2-5. OBIS Remote SDR Connector Specifications**

Description	Specification	Pin Locations
Cable style <sup>a</sup>	26 conductor total 3 twisted shielded pair	
Connectors	SDR both ends	
Cable length	1 meter (standard) 3 meters (maximum)	

a. Do NOT use a camera link cable—it will damage the system



Table 2-6. OBIS Remote SDR Cable Pinout Specifications (Sheet 1 of 2)

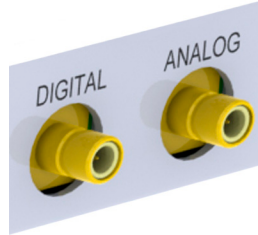
Signal Name	Pin Number	Pair Number	Direction	Function	Characteristics
RS-485 Inhibit	1		Digital Input	RS485 communication enable (flow control)	Default: High with 10K pull-up to 3.3V on laser. Must be set to less than 0.5V to enable RS-485 communication
Power Return	2		GND	Return for all power and digital lines	Common ground
Power Return	3		GND	Return for all power and digital lines	Common ground
Laser Diode Power	4		Power Input	+12 VDC for diode supply (no voltage => no diode current)	10 to 14V, up to 1.0A (16W maximum total including fan)
Laser Diode Power	5		Power Input	+12 VDC for diode supply (no voltage => no diode power)	Parallel pin for extra current capacity
System Power	6		Power Input	+12V for general supply	10 to 14V, up to 1.0A (16W maximum total including fan)
No Connect	7		Spare		
Laser Ready	8		Analog Out	Status signal: goes high when laser is stable at set power	> 2.5V when laser output impedance < 200 Ohm and output power is within $\pm 2\%$ set power
Baseplate Temperature	9		Analog Out	Status signal: 3-state-signal for base plate temperature	< 0.5V: baseplate temp below upper limit (10°C) 1.2 to 2V: baseplate between upper limit and (upper limit - 10°C) > 2.7V: baseplate above upper limit Impedance < 200 Ohm
RS-485 Communication Positive	10	1	Bidirectional	RS-485 communication line	See RS-485 specs for detailed description. Half-duplex 1 MBit 8N1 @ 0 to 3.3V.
Analog Modulation Negative	11	2	Analog Input	Negative analog modulation line	Negative line for analog power modulation (1Vpp differential, 0 to 4V on any line) 100 ohm termination
Digital Modulation Negative	12	3	Digital Input	Negative digital modulation line	Negative LVDS line for Laser ON/OFF 100 ohm termination
SDR In-Use Return	13		Bidirectional	Switching signal for SDR usage, USB inhibit	Connected to GND on laser head, signal must be looped back to pin 14 of SDR connector on host to enable SDR interface

**Table 2-6. OBIS Remote SDR Cable Pinout Specifications (Sheet 2 of 2)**

Signal Name	Pin Number	Pair Number	Direction	Function	Characteristics
SDR In-Use	14		Bidirectional	Switching signal for SDR usage, USB inhibit	Pulled-up with 10K to 3.3V on laser head, signal must be looped back to pin 13 of SDR connector on host to enable SDR interface
Power Return	15		GND	Return for all power and digital lines	Common ground
Power Return	16		GND	Return for all power and digital lines	Common ground
Laser Diode Power	17		Power Input	+12V DC for diode supply (no voltage => no diode power)	Parallel pin for extra current capacity
System Power	18		Power Input	+12V for general supply	Parallel pin for extra current capacity
System Power	19		Power Input	+12V for general supply	Parallel pin for extra current capacity
Diode Current	20		Analog Out	Status signal: actual diode current	2V = laser at maximum allowed diode current Output impedance < 200 Ohm
Laser Fault	21		Analog Out	Status signal: goes high when laser is in error state	< 0.5V: laser OK, > 2.5V: laser error Output impedance < 200 Ohm
Power Monitor	22		Analog Out	Status signal: actual laser output power	2V = laser at 100% of nominal power Output impedance < 200 Ohm
RS-485 Communication Negative	23	1	Bidirectional	RS-485 communication line	See RS-485 specs for detailed description.
Analog Modulation Positive	24	2	Analog Input	Positive analog modulation line	Positive line for analog power modulation (1Vpp differential, 0 to 4V on any line) 100 ohm termination
Digital Modulation Positive	25	3	Digital Input	Positive digital modulation line	Positive LVDS line for laser ON/OFF 100 ohm termination
Signal Return	26		GND	Return for power monitor	Common ground
Over-All Electrostatic Shield	Shell		GND	shield drain	Common ground
<b>Note:</b> The shields for twisted-pairs 1 to 3 are all connected to the shell-to-shell shield braid at both ends.					

**Modulation In Connectors**

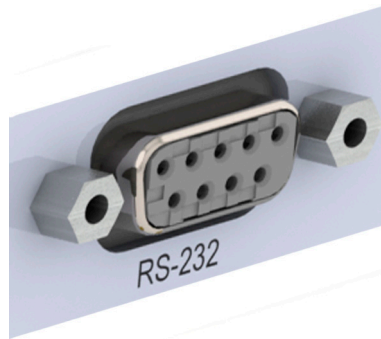
These SMB connectors (one digital, one analog) connect to buffer amplifiers within the OBIS Remote and are converted to differential signals to pass through the SDR cable to the laser head. The input impedance of the digital input is 50 ohms. The input impedance of the analog input is selectable to be either 50 ohms or 2K ohms.



**Figure 2-25. OBIS Remote Modulation In Connectors**

**RS-232 Connector**

Attaching an RS-232 cable between this connector and the RS-232 connector on a personal computer allows you to issue commands through the SDR connector.



**Figure 2-26. OBIS Remote RS-232 Connector**

**Table 2-7. OBIS Remote RS-232 Communication Settings**

Baud	115200
Parity	None
Data Bits	8
Stop Bits	1
Flow Control	None

**Table 2-8. OBIS Remote RS-232 Pin Connections**

Pin	Signal	Pin	Signal
1	DCD (Data Carrier Detect)	6	DSR (Data Set Ready)
2	Rx (Receive)	7	RTS (Request to Send)
3	Tx (Transmit)	8	CTS (Clear to Send)
4	DTR (Data Terminal Ready)	9	Unused
5	GND (Ground)		

**USB Connector**

Allows you to connect a PC to the OBIS Remote and issue commands. The commands directly pass through the SDR connector to the laser head.



**Figure 2-27. OBIS Remote USB Connector**

**Auto Start Switch**

The Auto Start switch eliminates the 5-second delay when starting the laser head and also eliminates the need to toggle the keyswitch to start the OBIS laser.




---

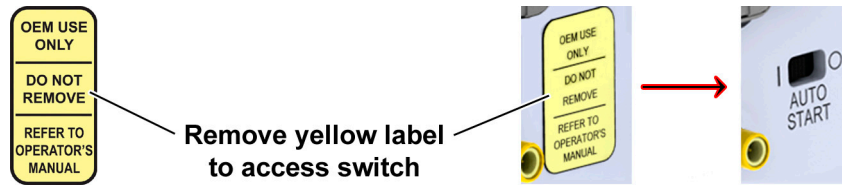
**WARNING!**  
**Enabling the Auto Start function defeats CDRH compliance.**

---



**NOTICE!**

The system is CDRH compliant only when used with a Remote with Auto Start = 0.



**Figure 2-28. OBIS Remote Auto Start Switch**

For information about using Auto Start, refer to “Enabling Auto Start” (p. 6-3)

**Interlock Control**

The OBIS Remote can be connected to a remote switch to disable the system (in the event that a door or panel is opened). The interlock switch must be wired in series with the interlock RCA connector. In addition, the user has the option of connecting an external LED in series with the interlock circuit (which provides a current source with 20 mA and up to 9V).

The following table lists laser behavior if the interlock circuit is opened during laser operation.

**Table 2-9. Behavior During Laser Operation**

		<b>Interlock Circuit Opened</b>	<b>Interlock Circuit Opened and Closed Again While Laser System is Powered</b>
Key Switch	OFF	No failure displayed.	No failure displayed.
	ON	No failure displayed. Laser status LED changes to blue, indicating the laser is in Standby. Close the interlock to clear.	No failure displayed. Light emission starts again automatically. To re-start light emission, close the interlock.



**WARNING!**

The interlock is a fused (12VDC) line. Do not ground the interlock or apply any outside power to the circuit.

**Interface Cable**

The OBIS laser system includes a full-function, 1-meter SDR-style cable connection between the laser head and the OBIS Remote.

For more information, refer to “OBIS Remote SDR Connector Specifications” - Table 2-5 (p. 2-18)

## Laser Head Modulation

The modulation connectors are pass-through only; the OBIS Remote itself does not do any modulation signal conditioning. The modulation connectors change the signals from being GND referred to LVDS signals. There is no change in timing behavior.

For more information, refer to:

- “OBIS Remote Dimensions” - Figure 2-44 (p. 2-39)
- “OBIS Remote Specifications” - Table 2-10 (p. 2-24)

## Specifications

*Table 2-10. OBIS Remote Specifications (Sheet 1 of 2)*

Parameter	Specification
OBIS Remote dimensions	68 x 105 x 33 mm
Laser-In connectors	One
Operating temperature range	10 to 50°C
Operating humidity range (non-condensing)	30 to 85%
Storage temperature range	-20 to 70°C
Storage humidity range (non-condensing)	30 to 95%
Interlock(s)	One key switch One dual pin
Power input	12V ± 2V DC
Mechanical expandability	Yes
Modulation capability	Pass-through only
Modulation connectors	One digital: 50 ohm input impedance, signal levels from 0 to 2.5V, capable of processing digital signals beyond 150 MHz. One analog: Selectable input impedance of either 50 ohms or 2K ohms. Signal levels from 0 to 5V, signal bandwidths beyond 1 MHz.
Modulation connector style	SMB
<b>LEDs</b>	
<i>Caution (Emission)</i> —On conditions	1. Laser head connected to OBIS Remote (SDR) 2. Power applied to laser diode
<i>Fault</i> —On conditions	1. If laser head reports fault 2. OBIS Remote fault
<i>Remote Control</i> —On conditions	1. Host USB enumerated 2. RS-232 connected
<i>Laser Ready</i> —On condition	Laser is running at set power ± 2%

Table 2-10. OBIS Remote Specifications (Sheet 2 of 2)

Parameter	Specification
<b>I/O Connector</b>	
<i>Connector Signals</i>	
1. Laser Fault output signal	0V - no fault 3.3V - fault
2. Laser Ready output signal	0V - otherwise, 3.3V - set power $\pm$ 2%
3. BP Temp output signal	0V - below (temp upper limit - 10C) 1.65V - between upper limit and (upper limit - 10C) 3.3V - above upper limit
4. Power Monitor signal	0 to 2V
5. Slow Digital Modulation input signal	Impedance - 10K input impedance, logic level 0 to 2.5V TTL logic level 1 kHz max speed
6. Diode Current Monitor signal	Current monitor is missing : 0..2V means 0..100% of maximal allowed current
Communications protocol to laser head	RS-485
USB connections	One
Power-In connector	2-pin Molex
RS-232 connector	DB-9 standard female
Laser-In connector	26-pin SDR

## OBIS 6-Laser Remote

The OBIS 6-Laser Remote is a small control box that allows you to connect up to six OBIS laser heads.




---

### **NOTICE!**

**To be CDRH compliant, you *must* use an OBIS Remote with the laser head—the laser head alone is *not* CDRH compliant.**

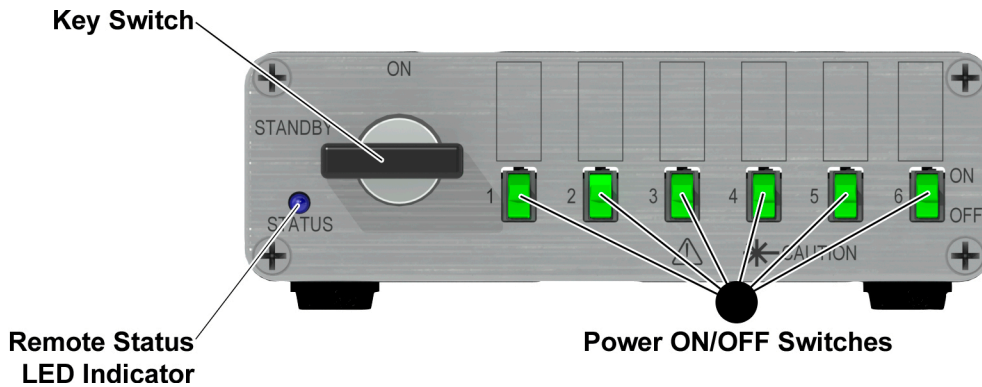
---

The OBIS 6-Laser Remote offers an ON/OFF key switch, a remote interlock, an LED indicator, and six switches to power six OBIS lasers. With these safety features, the system is compliant to CDRH regulations.

The OBIS 6-Laser Remote also has an internal auto start jumper that, once connected, will immediately power the lasers when power is attached to the OBIS 6-Laser Remote.

## Front Panel

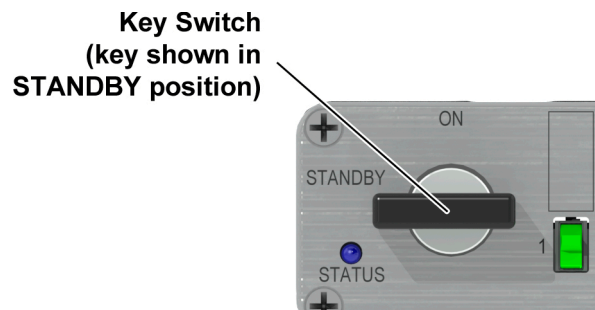
Indicators and connectors on the OBIS 6-Laser Remote front panel are shown in the following figure.



**Figure 2-29. OBIS 6-Laser Remote Front Panel**

## Key Switch

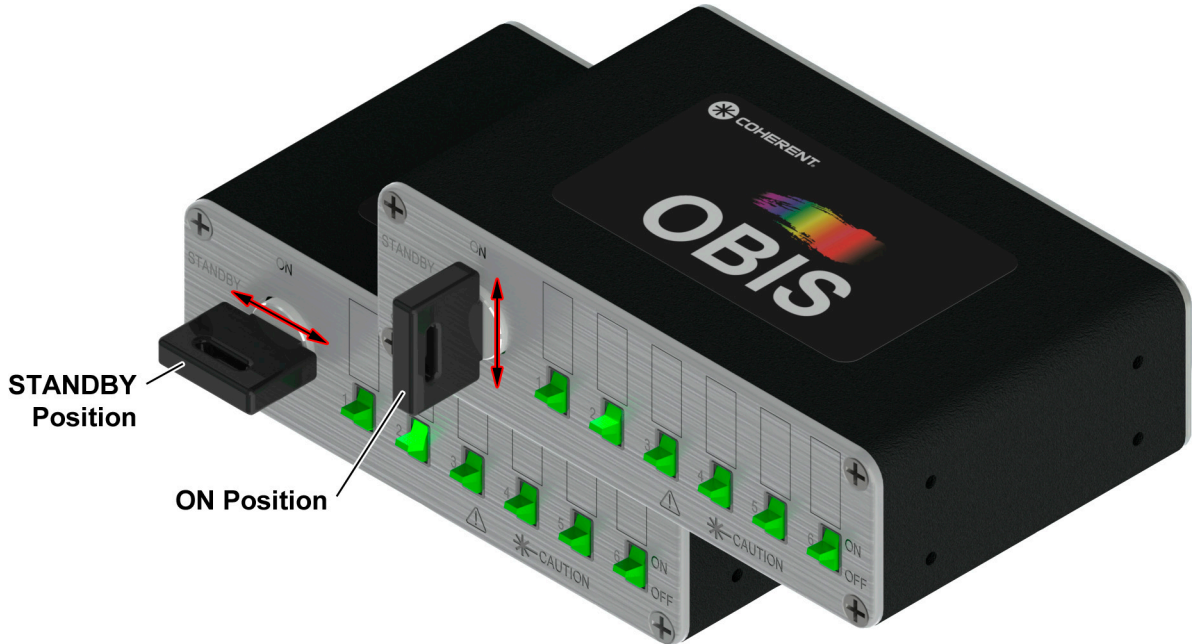
The OBIS 6-Laser Remote is provided with a key switch that prevents the generation of laser radiation when it is in the STANDBY position. Laser radiation may occur when the key is in the ON position. The key is removable when in the STANDBY position; it is not removable when it is in the ON position.



**Figure 2-30. OBIS 6-Laser Remote Key Switch**

The key switch acts as the CDRH Manual Reset feature: After an interlock fault or power interruption, the laser will not auto restart unless the key switch is first reset to STANDBY and then set back to ON. The following figure shows the key switch in the STANDBY and ON positions.

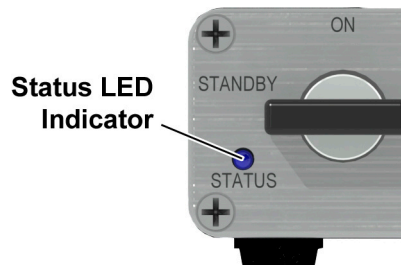




**Figure 2-31. OBIS 6-Laser Remote Key Switch STANDBY and ON Positions**

**Status LED Indicator**

The Status LED indicator on the front panel displays green, blue, or red. The color is determined by the state of the OBIS 6-Laser Remote and is explained, below.



**Figure 2-32. OBIS 6-Laser Remote Status LED Indicator**

Table 2-11 (p. 2-28) is the truth table for the LED indicator on the OBIS 6-Laser Remote. For a list of OBSI Remote LED states, refer to Table 2-2 (p. 2-10).

**Table 2-11. OBIS 6-Laser Remote Status LED States**

Mode	LED Status	Internal Auto Start Jumper	Key Switch Position	Interlock Status
1	Blue	Out	STANDBY	X
2	Blinking Blue	Out	ON at power up	X
3	Green	Out	Cycle STANDBY to ON	Closed
4	Blue	In	STANDBY	X
5	Green	In	ON	Closed
6	Red	X	ON	Open

The conditions described above are at power on.

- **Mode 1:** A blue LED with the internal auto start jumper not installed and the key switch in the STANDBY position. The interlock can be either in or out at this time, as the OBIS 6-Laser Remote is not looking for the interlock plug.
- **Mode 2:** A blinking blue LED that displays when you have the key switch in the ON position when you power up the OBIS 6-Laser Remote. You must cycle the key switch to STANDBY, then ON, to clear this condition.
- **Mode 3:** This green LED appears when you have correctly powered up the OBIS 6-Laser Remote, cycled to the ON position, there is no internal auto start jumper, and the interlock plug is in place.
- **Mode 4:** This is the first of the configurations that includes the auto start jumper. When you power up the OBIS 6-Laser Remote and have the key switch on STANDBY, the LED will be blue.
- **Mode 5:** This is the correct sequence for the OBIS 6-Laser Remote when the internal auto start jumper is in place. The LED will be green when you power the OBIS 6-Laser Remote with the key switch ON and the internal auto start jumper on the interlock plug is connected.
- **Mode 6:** This red LED indicates that the interlock has been opened with the key switch in the ON position.




---

**WARNING!**

**When the key switch is in the ON position, the interlock plug is connected, and the laser power switches are in the ON position and illuminated, there is a possibility of laser emission.**

---

**Power ON/OFF Switches**

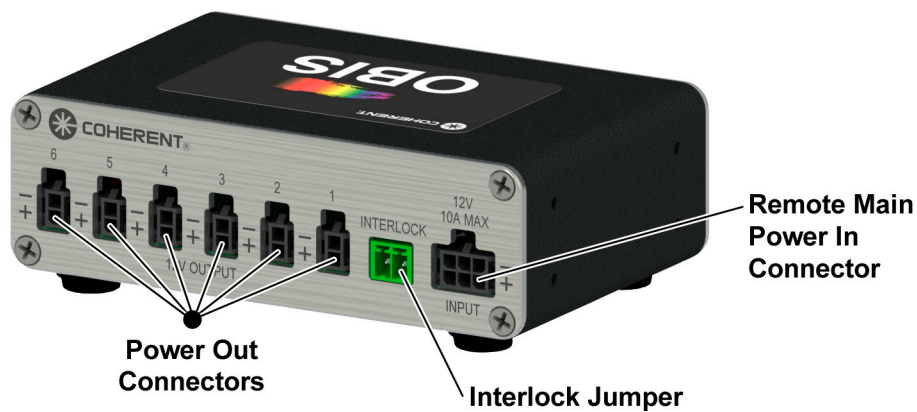
Applies power to the individual lasers. Each individual switch illuminates green when power is applied.



*Figure 2-33. OBIS 6-Laser Remote Power ON/OFF Switches*

**Back Panel**

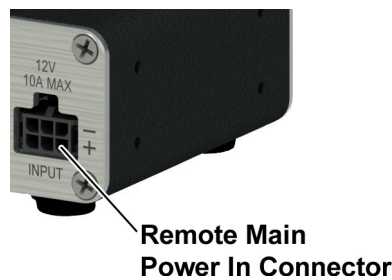
The back panel of the OBIS 6-Laser Remote (shown below) has the following connectors: Remote Main power in, (six) power out, and the interlock jumper. These are discussed below.



*Figure 2-34. OBIS 6-Laser Remote Back Panel*

**Power In Connector**

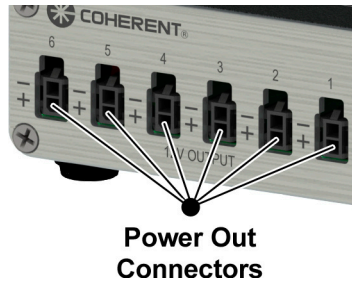
Power is supplied to the OBIS 6-Laser Remote through a 6-pin Molex connector. The Astrodyne power supply is also equipped with an ON/OFF switch to power the device.



*Figure 2-35. OBIS 6-Laser Remote Main Power In Connector*

**Power Out Connectors**

Power is supplied to the laser heads through six 5.5 mm 2-pin connectors: Molex SDA43025-0200. Two crimp-style contact pins are also needed: Molex 43031-0009. The cable is one meter long.



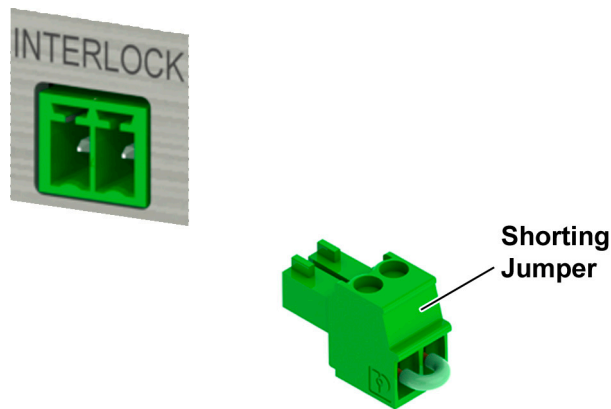
**Figure 2-36. OBIS 6-Laser Remote Power Out Connectors**

**Table 2-12. OBIS 6-Laser Power Out Connector Pinout Specifications**

Signal Name	Pin Number	Pin Locations
Positive (+)	1	
Ground	2	

**Interlock Jumper**

This is a mechanical-style jumper for CDRH interlock. The interlock has terminal style connections that allow connection to an external control device.



**Figure 2-37. OBIS 6-Laser Remote Interlock Jumper**

## Auto Start Jumper and Fuse Replacement

The Auto Start feature allows the operator to start the OBIS as soon as the laser finishes its warm up and will automatically start the laser without the need to toggle the keyswitch.

The auto start jumper is located inside the OBIS 6-Laser Remote and is accessed by removing the top four screws on the front and back covers and then removing the cover (refer to Figure 2-38, below). The remote jumper is located at the back of the OBIS 6-Laser Remote, near the corner. The auto start jumper is a 100 mil shunt. The jumper may be stored in the OBIS 6-Laser Remote by attaching the jumper to only one of the pins.

The 10A fuse is also accessed by removing the four screws holding the front or back cover. The fuse is located in the opposite corner from the auto start jumper.



---

### WARNING!

**Enabling the Auto Start function defeats CDRH compliance.**

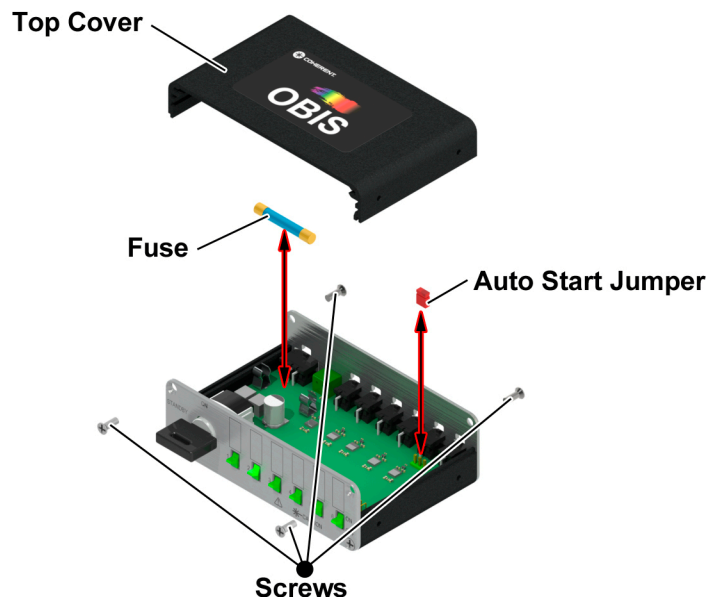
---

---

### NOTICE!

**Removing the Obis 6-Laser Remote cover to replace the fuse or to set the Auto Start Jumper does not void the unit warranty.**

---



*Figure 2-38. OBIS 6-Laser Remote Exploded View*

**Remote Interlock**

The OBIS 6-Laser Remote is provided with an interlock circuit that prevents the generation of laser radiation when open. For more information, refer to "Remote Interlock" (p. 1-8).

**Interlock Control**

The OBIS 6-Laser Remote can be connected to a remote switch to disable the system (in the event that a door or panel is opened). The interlock switch must be wired in series with the interlock RCA connector. In addition, the user has the option of connecting an external LED in series with the interlock circuit (which provides a current source with 20 mA and up to 9V).

The following table lists laser behavior if the interlock circuit is opened during laser operation.

**Table 2-13. Behavior During Laser Operation**

		<b>Interlock Circuit Opened</b>	<b>Interlock Circuit Opened and Closed Again While Laser System is Powered</b>
Key Switch	OFF	No failure displayed.	No failure displayed.
	ON	Failure displayed by red LED status on front panel. Need to close interlock circuit to clear failure status.	Red LED displayed. Key switch must be cycled to STANDBY and then back to ON for lasers to start lasing again.



**WARNING!**

**The interlock is a fused (12VDC) line. Do not ground the interlock or apply any outside power to the circuit.**

**Specifications**

**Table 2-14. OBIS 6-Laser Remote Specifications**

<b>Parameter</b>	<b>Specification</b>
Remote dimensions	68 x 105 x 33 mm
Laser Out connectors	Six @ 12VDC 1.5A
Operating temperature range	10 to 50°C
Operating humidity range (non-condensing)	30 to 85%
Storage temperature range	-20 to 70°C
Storage humidity range (non-condensing)	30 to 95%
Interlock(s)	One key switch One dual pin
Power input	12V ± 2V DC @ 10A
Mechanical expandability	Yes

## Humidity

(LX lasers only) The OBIS laser system includes an active thermoelectric cooler to maintain the diode and optics at 25°C. The humidity and ambient temperature around the laser needs to be considered to prevent condensation on the diode and optics. Table 2-15, below, contains boxes representing the dew point numbers. The diode set temperature is 25°C. Dew points above 22°C (shaded in gray) could cause concern for condensation.

**Table 2-15. Safe Operating Humidity Levels (LX lasers only)**

Air Temp (°C)	Relative Humidity (%)																		
	100	95	90	85	80	75	70	65	60	55	50	45	40	35	30	25	20	15	10
45	45.0	44.0	43.0	41.9	40.7	39.5	38.2	36.9	35.4	33.8	32.1	30.3	28.2	25.9	23.4	20.4	16.8	12.3	6.3
44	44.0	43.0	42.0	40.9	39.8	38.5	37.3	35.9	34.5	32.9	31.2	29.4	27.3	25.1	22.5	19.5	16.0	11.6	5.6
43	43.0	42.0	41.0	39.9	38.8	37.6	36.3	35.0	33.5	32.0	30.3	28.5	26.5	24.2	21.6	18.7	15.2	10.8	4.8
42	42.0	41.0	40.0	38.9	37.8	36.6	35.4	34.0	32.6	31.1	29.4	27.6	25.6	23.3	20.8	17.9	14.4	10.0	4.1
41	41.0	40.0	39.0	38.0	36.8	35.7	34.4	33.1	31.7	30.1	28.5	26.7	24.7	22.5	19.9	17.0	13.5	9.2	3.3
40	40.0	39.0	38.0	37.0	35.9	34.7	33.5	32.1	30.7	29.2	27.6	25.8	23.8	21.6	19.1	16.2	12.7	8.4	2.6
39	39.0	38.0	37.0	36.0	34.9	33.7	32.5	31.2	29.8	28.3	26.6	24.9	22.9	20.7	18.2	15.4	11.9	7.6	1.8
38	38.0	37.1	36.1	35.0	33.9	32.8	31.6	30.2	28.9	27.4	25.7	24.0	22.0	19.8	17.4	14.5	11.1	6.8	1.1
37	37.0	36.1	35.1	34.0	33.0	31.8	30.6	29.3	27.9	26.4	24.8	23.1	21.1	19.0	16.5	13.7	10.3	6.1	0.3
36	36.0	35.1	34.1	33.1	32.0	30.8	29.6	28.4	27.0	25.5	23.9	22.2	20.2	18.1	15.7	12.8	9.5	5.3	-0.4
35	35.0	34.1	33.1	32.1	31.0	29.9	28.7	27.4	26.1	24.6	23.0	21.3	19.4	17.2	14.8	12.0	8.7	4.5	-1.2
34	34.0	33.1	32.1	31.1	30.0	28.9	27.7	26.5	25.1	23.7	22.1	20.4	18.5	16.3	13.9	11.2	7.8	3.7	-1.9
33	33.0	32.1	31.1	30.1	29.1	28.0	26.8	25.5	24.2	22.7	21.2	19.5	17.6	15.5	13.1	10.3	7.0	2.9	-2.7
32	32.0	31.1	30.1	29.2	28.1	27.0	25.8	24.6	23.2	21.8	20.3	18.6	16.7	14.6	12.2	9.5	6.2	2.1	-3.4
31	31.0	30.1	29.2	28.2	27.1	26.0	24.9	23.6	22.3	20.9	19.3	17.7	15.8	13.7	11.4	8.6	5.4	1.3	-4.2
30	30.0	29.1	28.2	27.2	26.2	25.1	23.9	22.7	21.4	20.0	18.4	16.8	14.9	12.8	10.5	7.8	4.6	0.5	-4.9
29	29.0	28.1	27.2	26.2	25.2	24.1	23.0	21.7	20.4	19.0	17.5	15.8	14.0	12.0	9.7	7.0	3.8	-0.3	-5.7
28	28.0	27.1	26.2	25.2	24.2	23.1	22.0	20.8	19.5	18.1	16.6	14.9	13.1	11.1	8.8	6.1	2.9	-1.1	-6.5
27	27.0	26.1	25.2	24.3	23.2	22.2	21.0	19.8	18.6	17.2	15.7	14.0	12.2	10.2	7.9	5.3	2.1	-1.8	-7.2
26	26.0	25.1	24.2	23.3	22.3	21.2	20.1	18.9	17.6	16.2	14.8	13.1	11.3	9.3	7.1	4.4	1.3	-2.6	-8.0
25	25.0	24.1	23.2	22.3	21.3	20.3	19.1	18.0	16.7	15.3	13.8	12.2	10.5	8.5	6.2	3.6	0.5	-3.4	-8.7
24	24.0	23.1	22.3	21.3	20.3	19.3	18.2	17.0	15.7	14.4	12.9	11.3	9.6	7.6	5.3	2.8	-0.4	-4.2	-9.5
23	23.0	22.2	21.3	20.3	19.4	18.3	17.2	16.1	14.8	13.5	12.0	10.4	8.7	6.7	4.5	1.9	-1.2	-5.0	-10.3
22	22.0	21.2	20.3	19.4	18.4	17.4	16.3	15.1	13.9	12.5	11.1	9.5	7.8	5.8	3.6	1.1	-2.0	-5.8	-11.0
21	21.0	20.2	19.3	18.4	17.4	16.4	15.3	14.2	12.9	11.6	10.2	8.6	6.9	4.9	2.8	0.2	-2.8	-6.6	-11.8
20	20.0	19.2	18.3	17.4	16.4	15.4	14.4	13.2	12.0	10.7	9.3	7.7	6.0	4.1	1.9	-0.6	-3.6	-7.4	-12.5

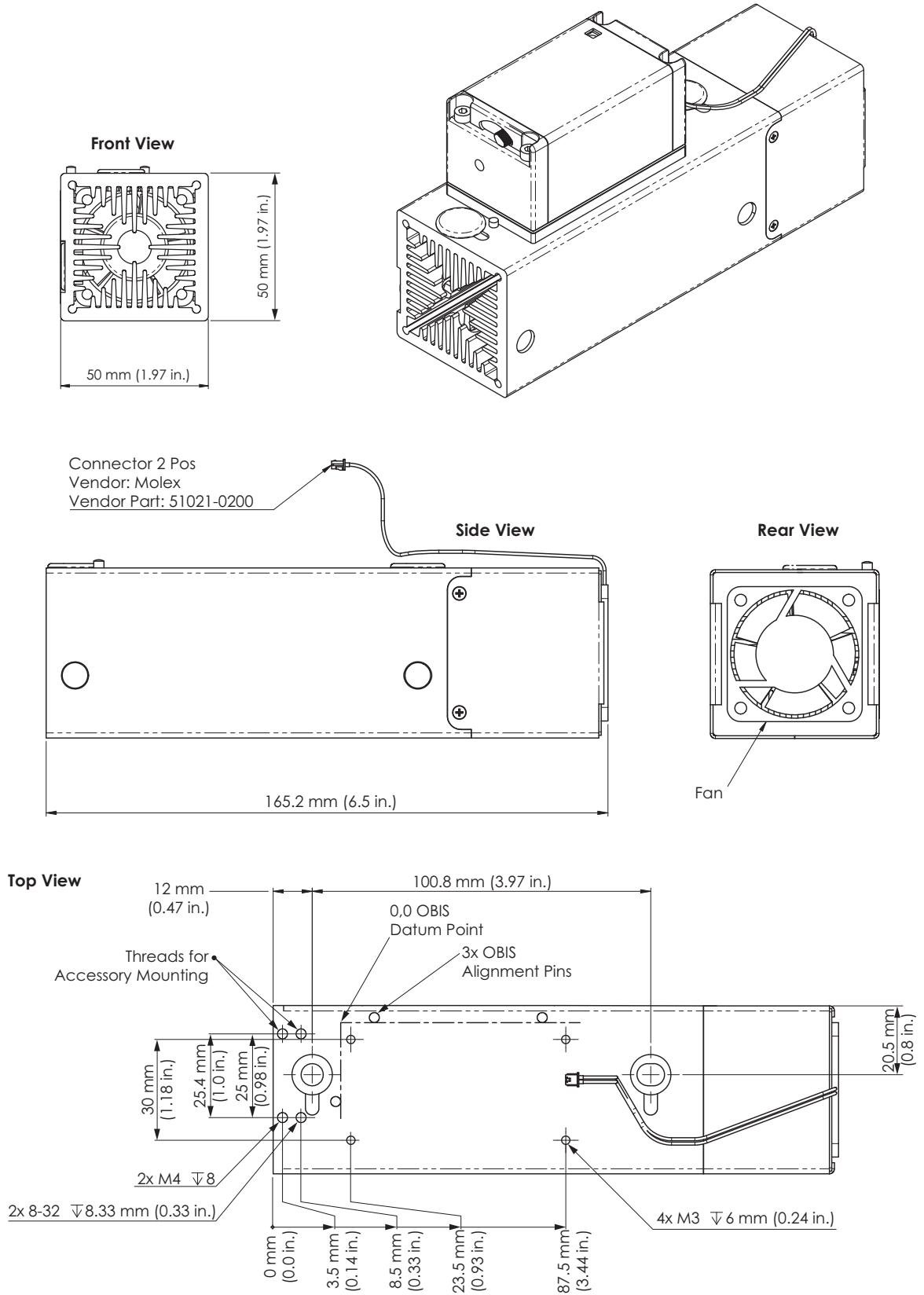
Shaded area in the table represents condensing. For example, with the cold block at 25°C and the air temperature 30°C with 80% relative humidity, the condition is condensing. At 70% relative humidity, it is no longer condensing.

## **Dimensions**

Dimensions included in this section:

- Optional heat sink (p. 2-35)
- Laser head (p. 2-36)
- OBIS Remote Power supply (p. 2-37)
- OBIS 6-Laser Remote Power supply (p. 2-38)
- OBIS Remote (p. 2-39)
- OBIS Remote (with mounting brackets) (p. 2-40)
- OBIS 6-Laser Remote (p. 2-41)





**Figure 2-39. Optional Heat Sink Dimensions**

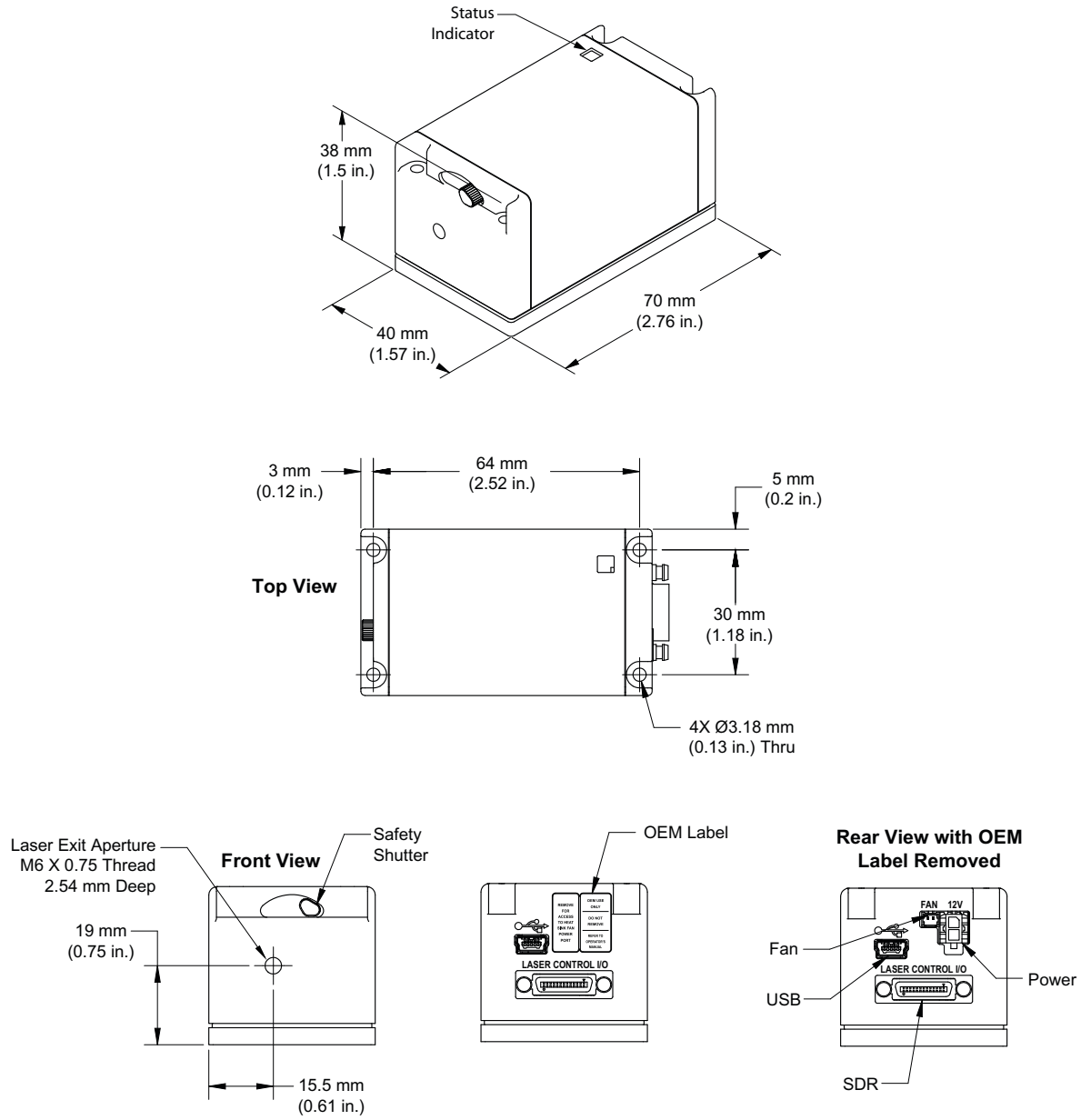


Figure 2-40. Laser Head Dimensions

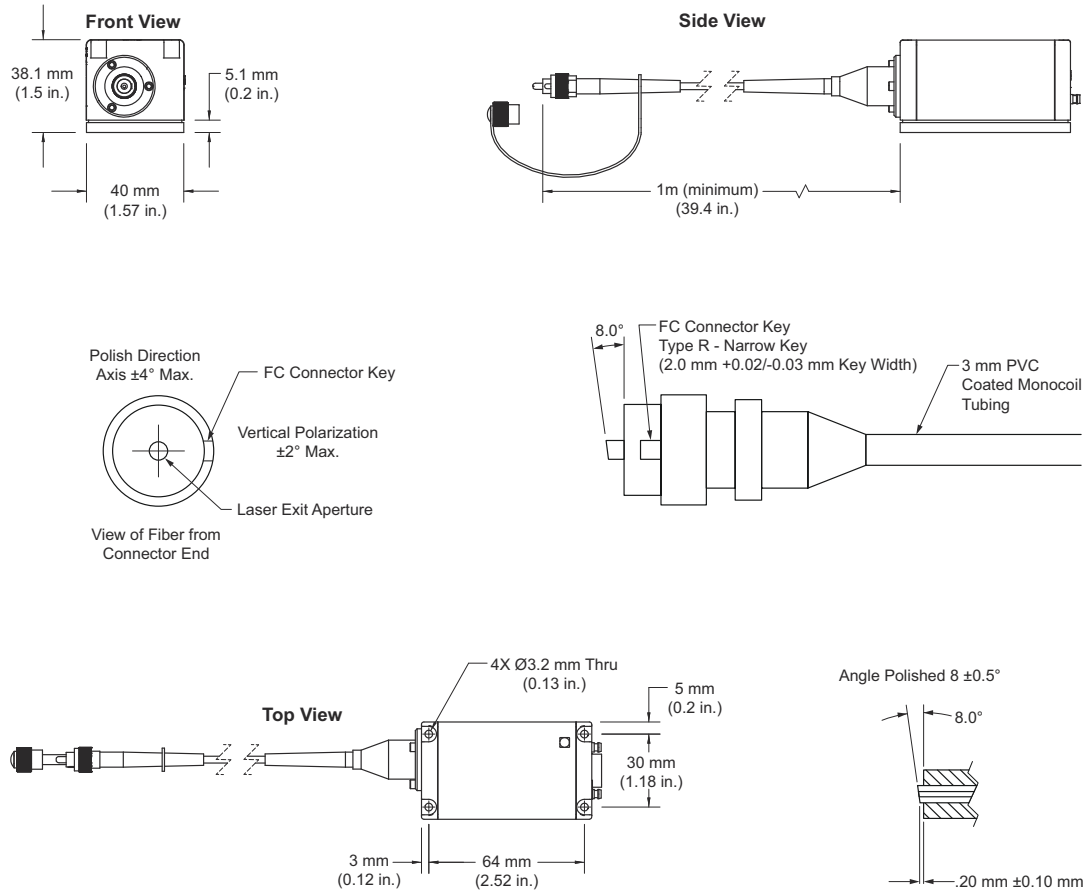


Figure 2-41. OBIS FP Laser Head Dimensions

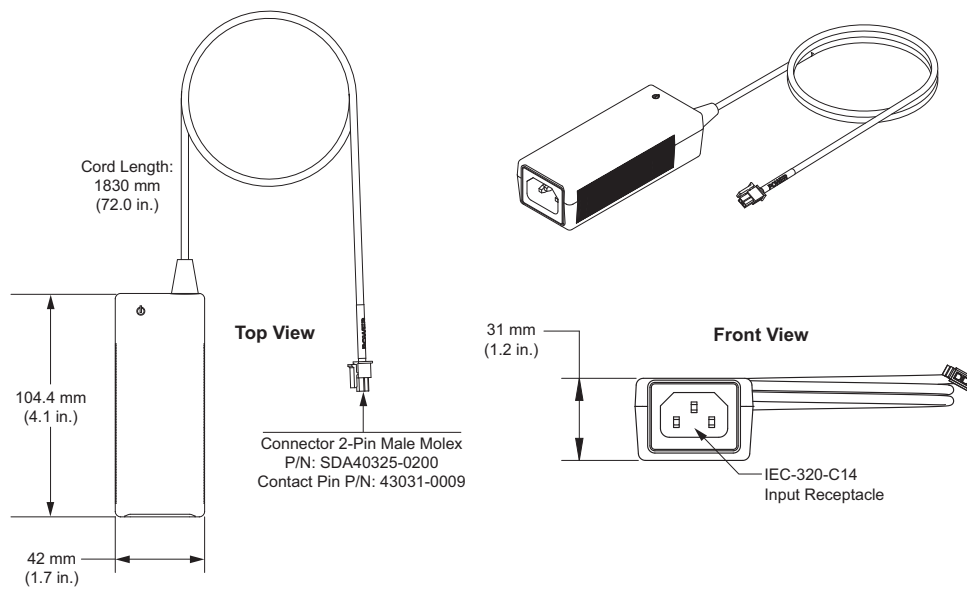
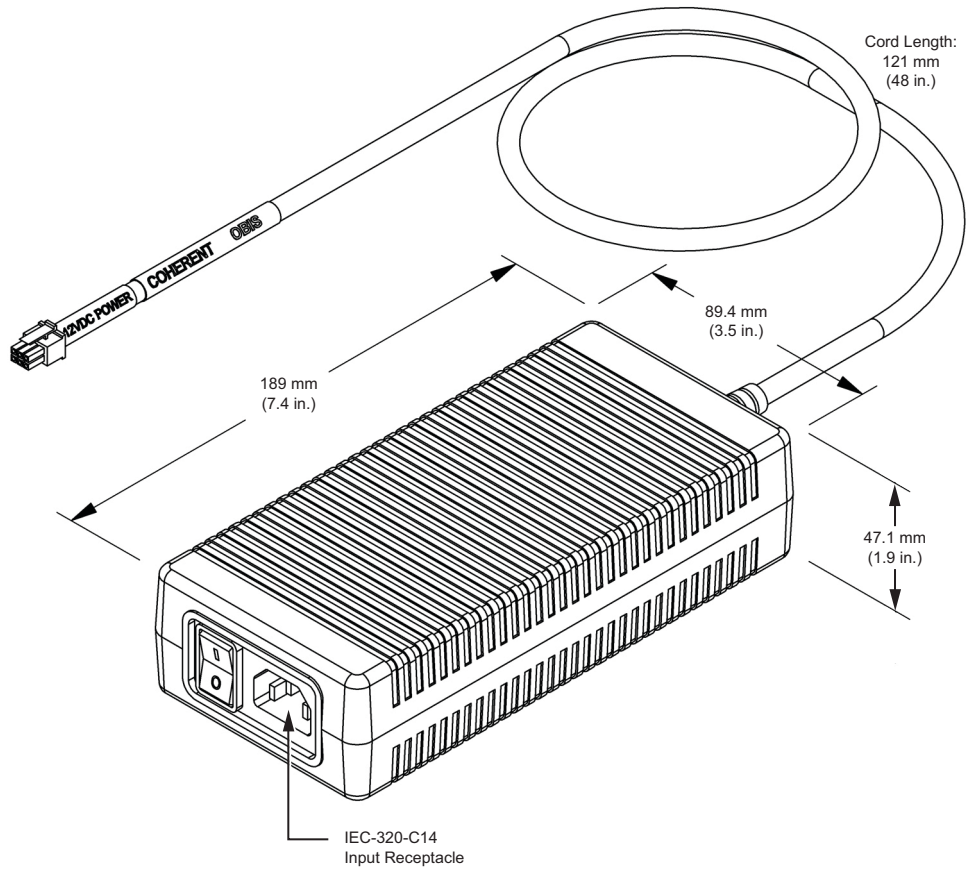


Figure 2-42. OBIS Remote Power Supply Dimensions



**Figure 2-43. OBIS 6-Laser Remote Power Supply Dimensions**

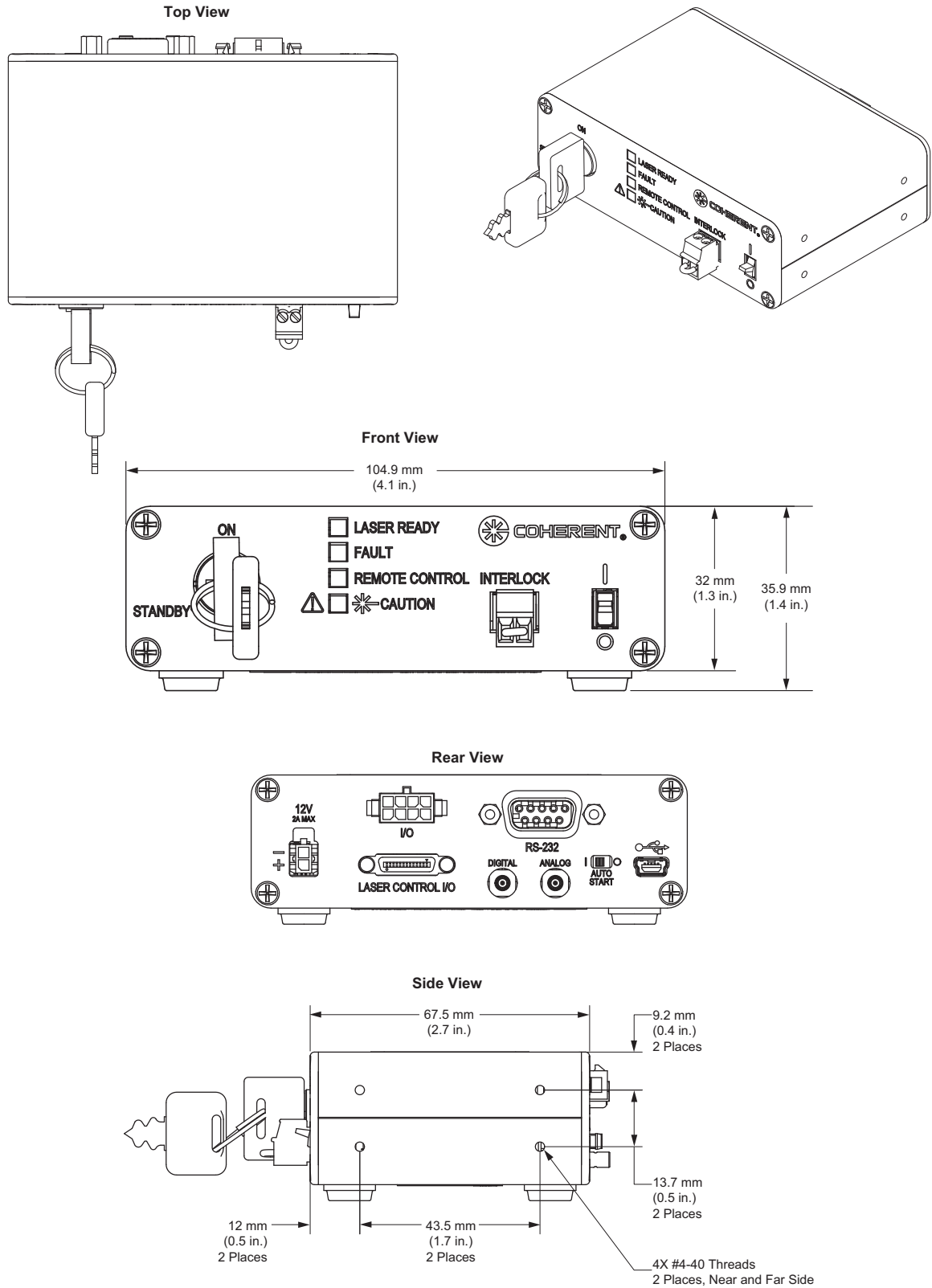
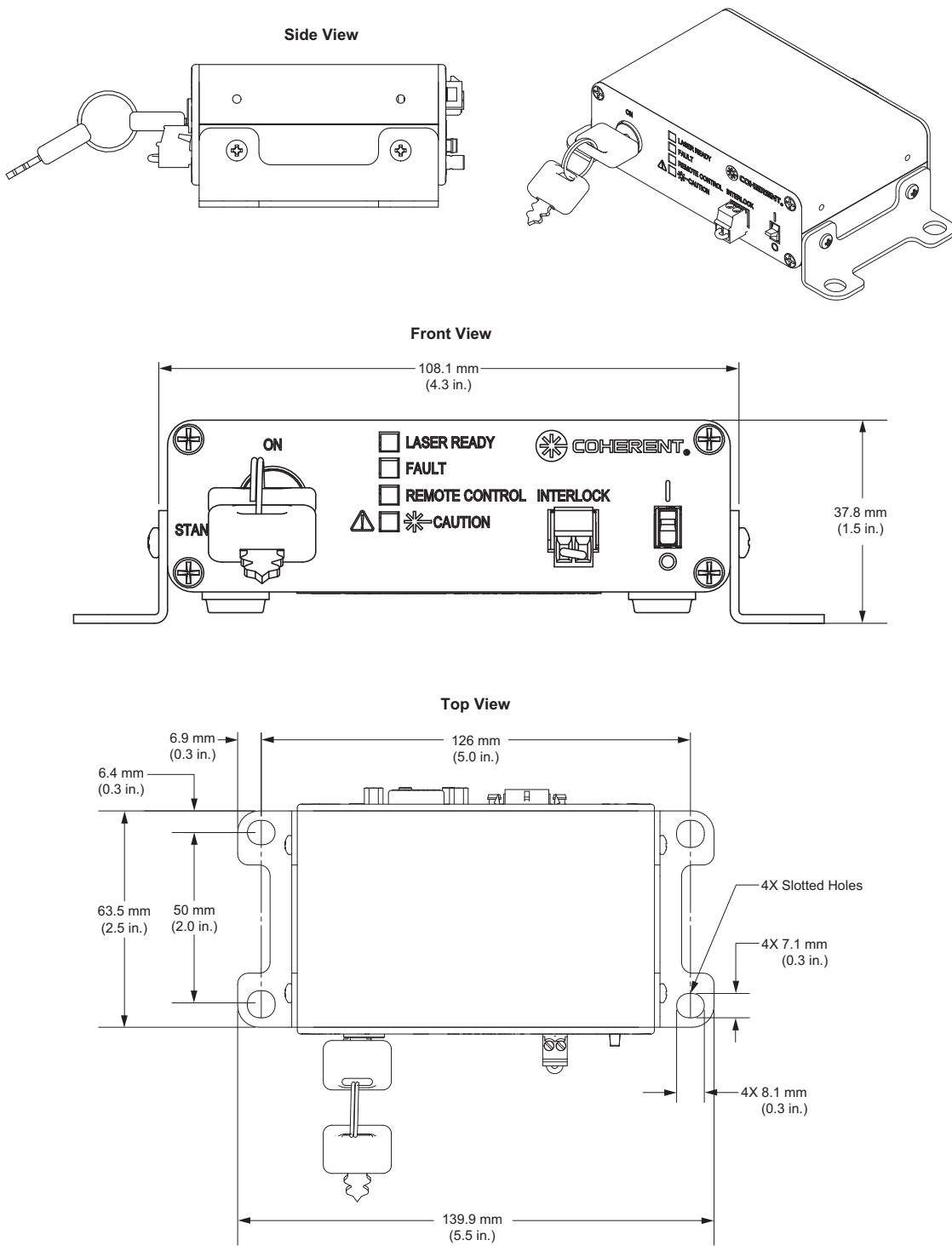
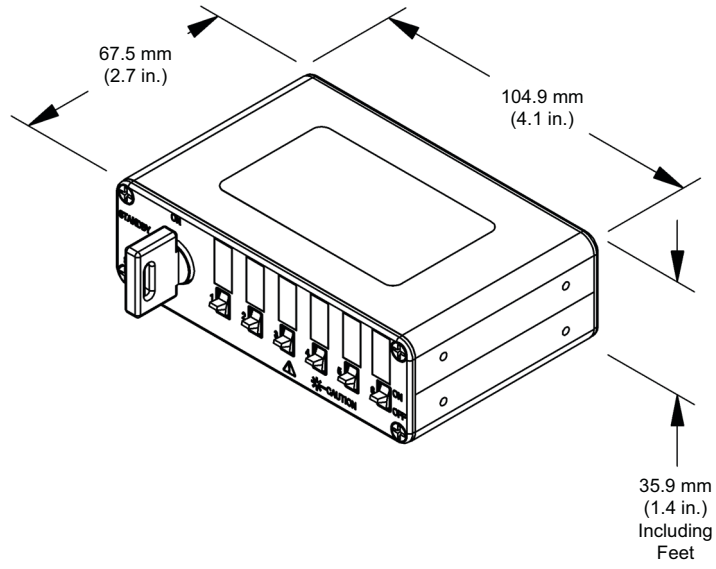


Figure 2-44. OBIS Remote Dimensions



**Figure 2-45. OBIS Remote (With Mounting Brackets) Dimensions**



**Figure 2-46. OBIS 6-Laser Remote Dimensions**





## SECTION THREE: INSTALLATION

In this section:

- Overview of the standard installation procedure (this page)
  - Installing the optional heat sink (p. 3-2)
  - Mounting the laser head (p. 3-5)
  - Connecting the SDR cable (p. 3-9)
  - Connecting power (p. 3-10)
  - Adding optional fan power (p. 3-10)
  - Connecting the interlock (p. 3-11)
  - Connecting optional USB/RS-232 (p. 3-11)
- Heat sink requirement (p. 3-12)

### **Overview of the Standard Installation Procedure**

The procedure presented in this section explains how to connect the OBIS laser head and OBIS Remote. For details on installing the laser head *without* the OBIS Remote, refer to “Installing and Operating the OEM Laser Head Only” (p. 6-4).



---

#### ***NOTICE!***

**Operating the laser head without the OBIS Remote is non-CDRH compliant.**

---

The installation procedure consists of the following steps:

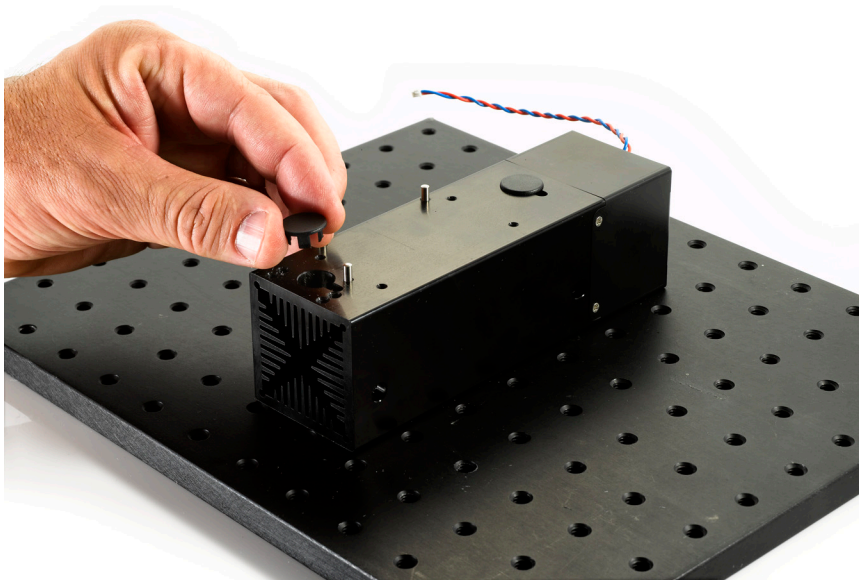
1. Installing the optional heat sink (p. 3-2)
2. Mounting the laser head (p. 3-5)
3. Connecting the SDR cable between the laser head and the OBIS Remote (p. 3-9)
4. Connecting power to the OBIS Remote or the OBIS 6-Laser Remote (p. 3-10)
5. Adding optional fan power to the laser head (p. 3-10)
6. Connecting the interlock to the OBIS Remote or the OBIS 6-Laser Remote (p. 3-11)

7. Connecting optional USB/RS-232 (for remote control)  
(p. 3-11)

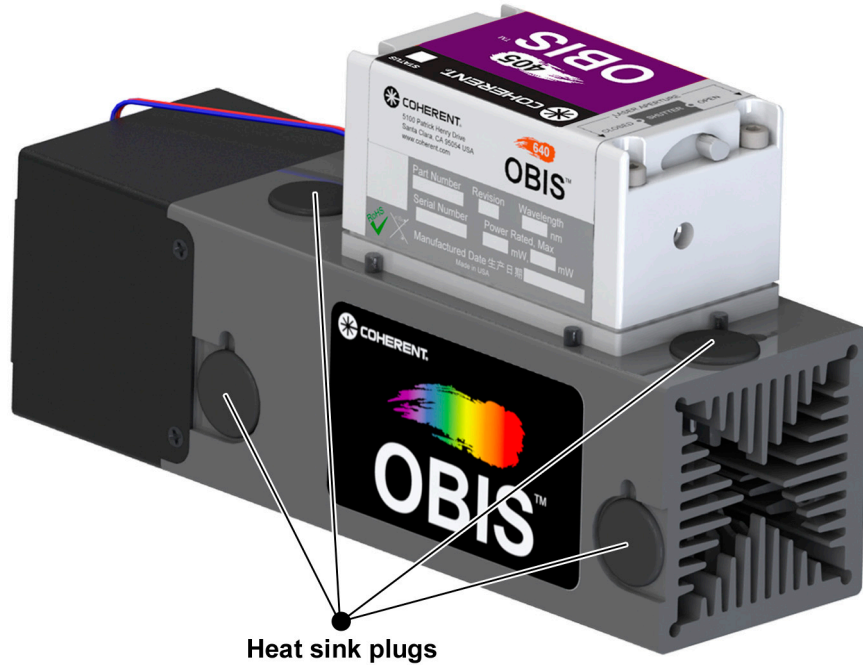
## **Installing the Optional Heat Sink**

The Coherent optional heat sink is the result of significant design research and testing. The mounting of any laser is important to extend the stability of the beam over time and temperature. The heat sink provides proper thermal dissipation and mechanical positioning.

1. Remove the heat sink plugs.



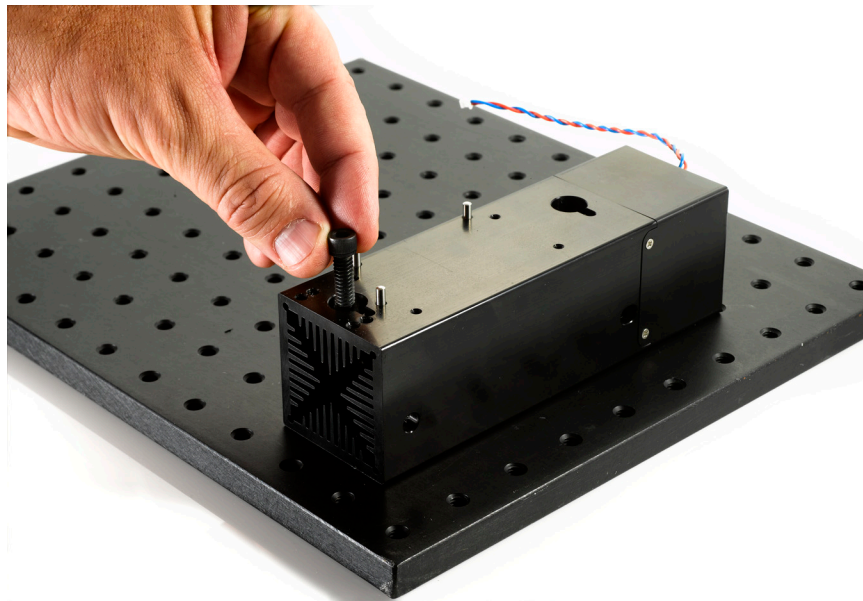
***Figure 3-1. Remove the Heat Sink Plugs***



Heat sink plugs

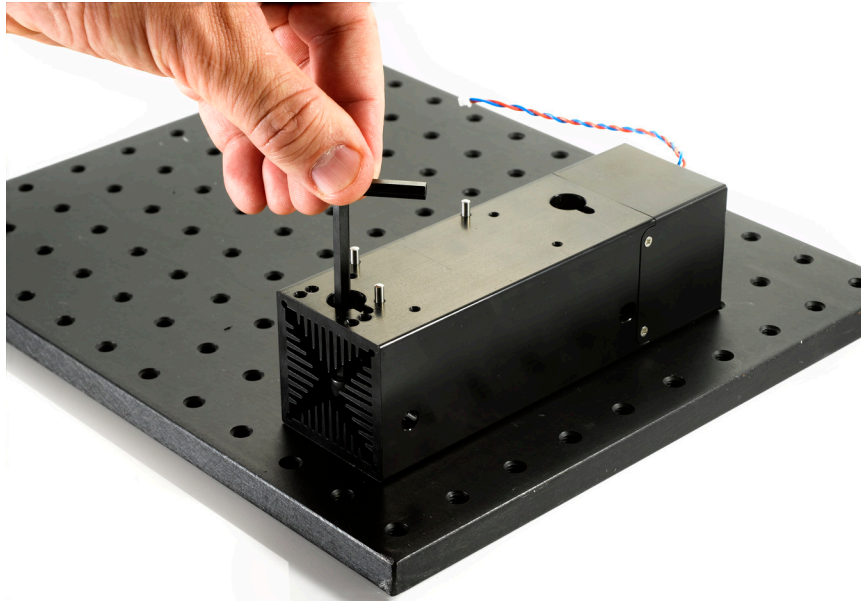
**Figure 3-2. Heat Sink Plug Locations**

2. Bolt the heat sink to the proposed laser location. Ensure the heat sink ends remain unobstructed for proper air flow.



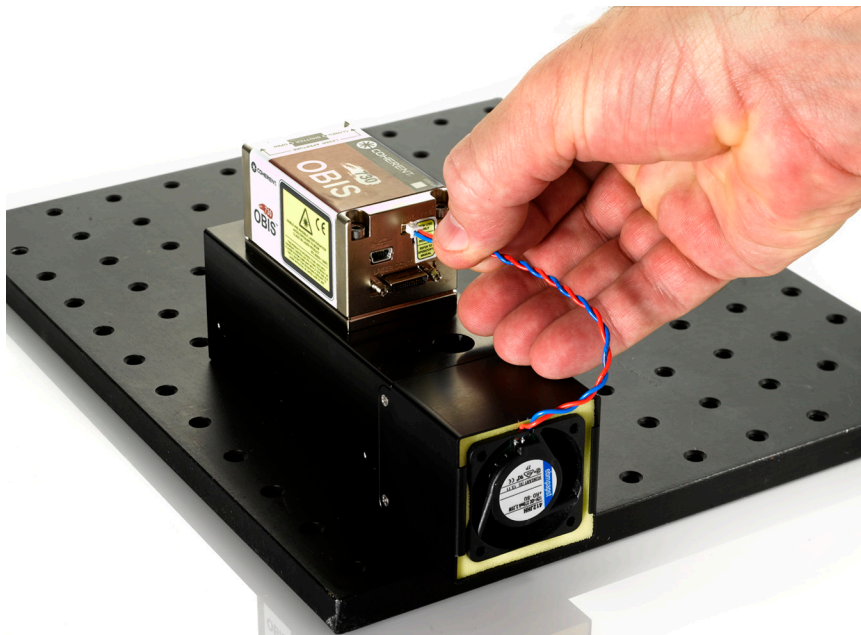
**Figure 3-3. Bolt the Heat Sink to the Proposed Laser Location**

3. Torque the two M6 mounting screws to 4.5 Nm (635 oz in).



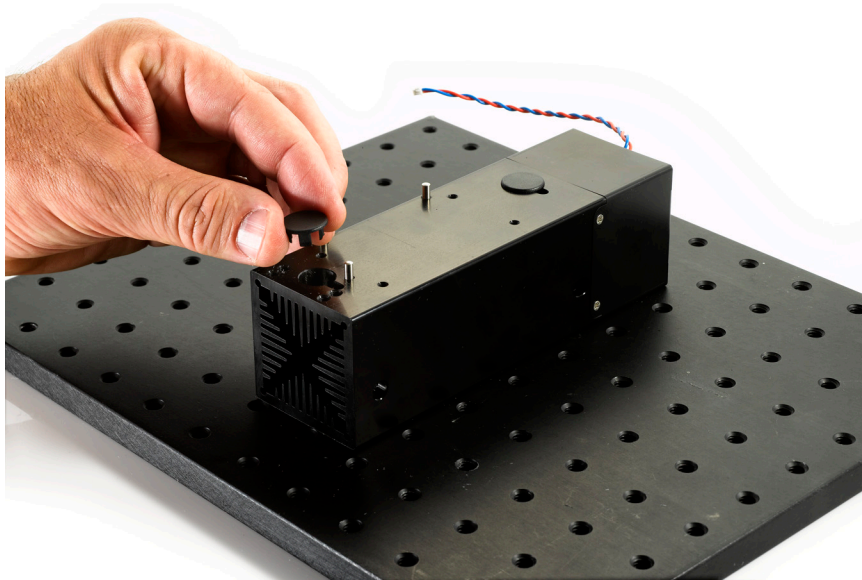
**Figure 3-4. Torque the Mounting Screws**

4. If fan operation is required, connect the fan to the OBIS power supply with the cable provided with the heat sink. The fan cable will allow power to be supplied to the heat sink fan and to the OBIS, simultaneously.



**Figure 3-5. Connect the Fan to the OBIS Power Supply**

5. Replace the heat sink plugs back to the original position in the heat sink. *This is mandatory to ensure the best cooling efficiency.*



*Figure 3-6. Replace the Heat Sink Plugs*

### **Mounting the Laser Head**

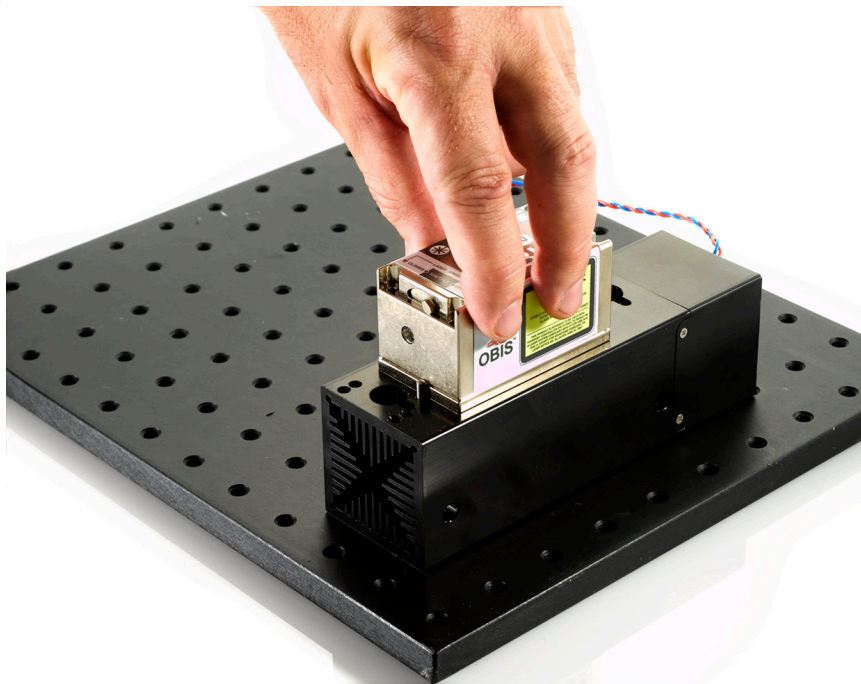
1. Secure the Coherent heat sink or your own heat sink to the proposed laser location—refer to “Installing the Optional Heat Sink,” above. Ensure that the heat sink ends remain unobstructed for proper air flow.



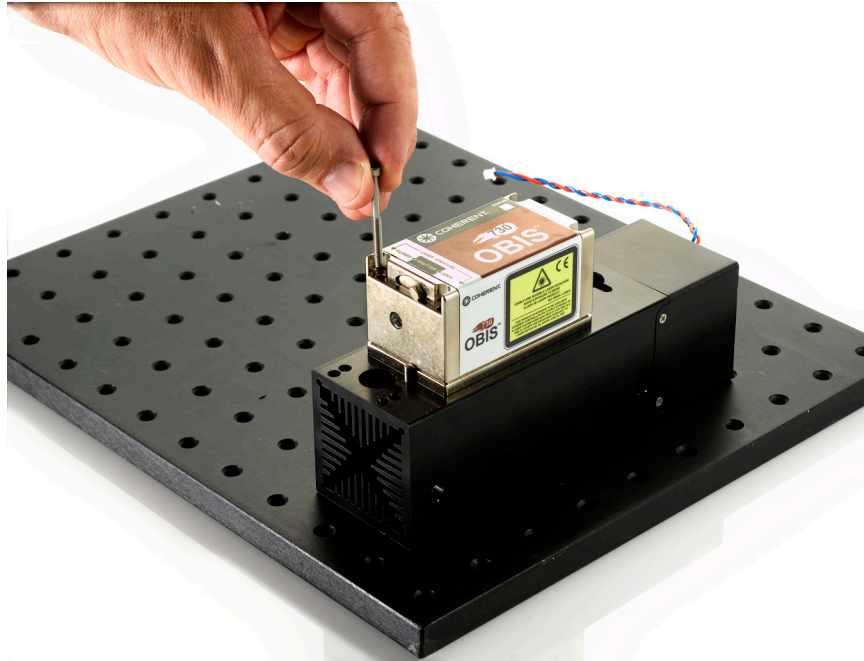
2. Align the laser head with the heat sink and then secure it to the heat sink with the M3 screw kit (provided). Use the washers to spread the tightening force.



***Figure 3-7. Provided Mounting Screw Kit for OBIS Laser Head***

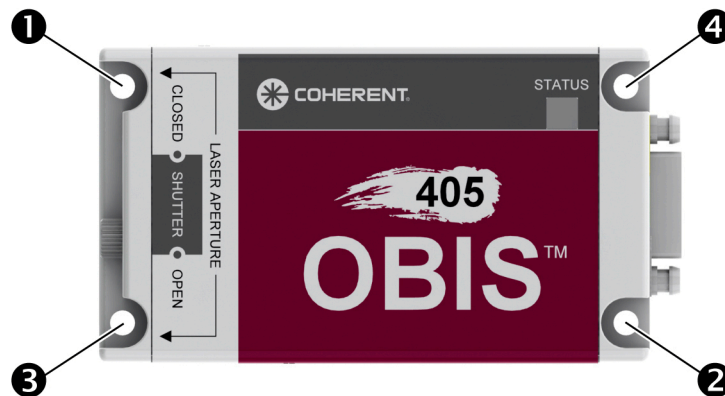


***Figure 3-8. Align the Laser Head to the Heat Sink***

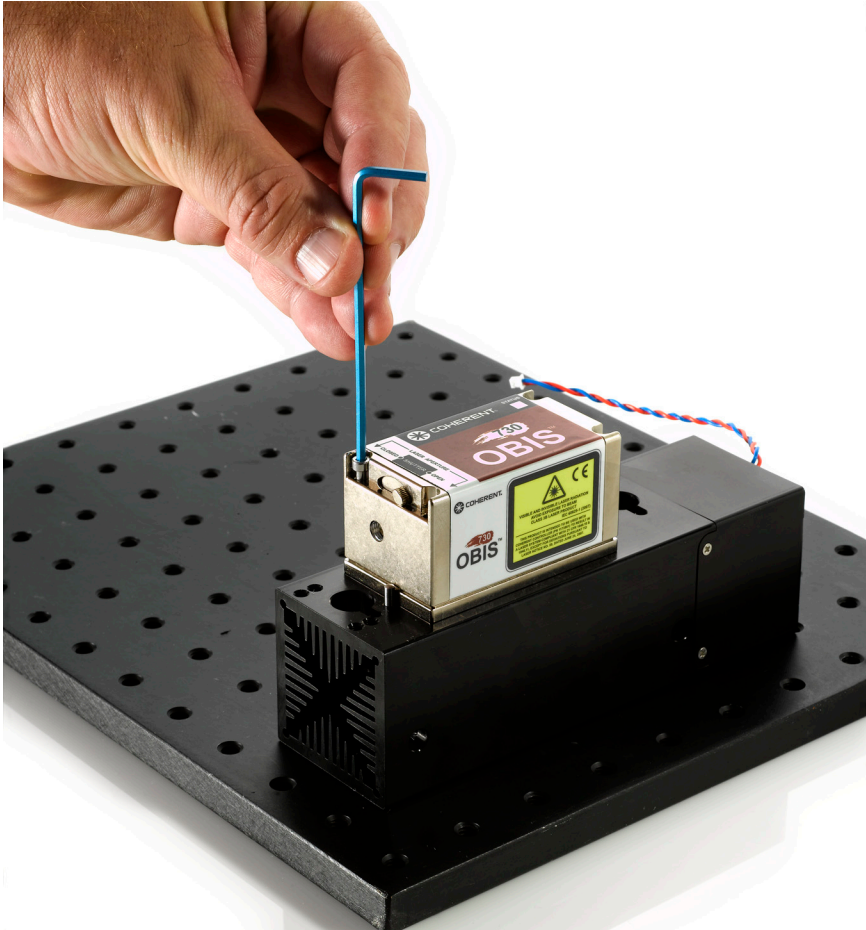


**Figure 3-9. Secure the Laser Head to the Heat Sink**

3. Tighten screws in a diagonal pattern to ensure optimum pointing stability. Torque the mounting screws to .25 N·m (35.4 oz·in.) in the following sequence: 1-2-3-4. Use the same diagonal pattern for the final torque setting of 1 N·m (141.6 oz·in.).



**Figure 3-10. Tightening Pattern for Mounting the OBIS Laser Head**



**Figure 3-11. Tighten the Mounting Screws**



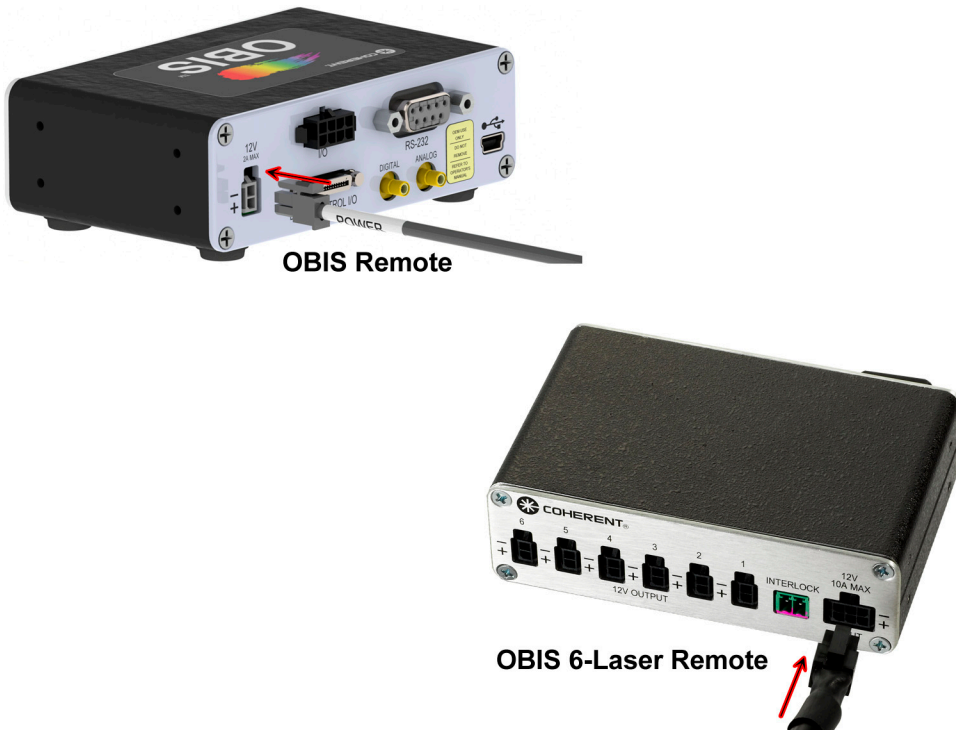
## Connecting the SDR Cable

Connect the 26-pin, type: 3M 12226-1150-00FR, SDR connector to the laser head and the OBIS Remote. Refer to Table 2-6 (p. 2-19) for pin assignment and functions.



*Figure 3-12. Connecting the SDR Cable*

**Connecting Power** Connect the power cord to the OBIS Remote or the OBIS 6-Laser Remote.

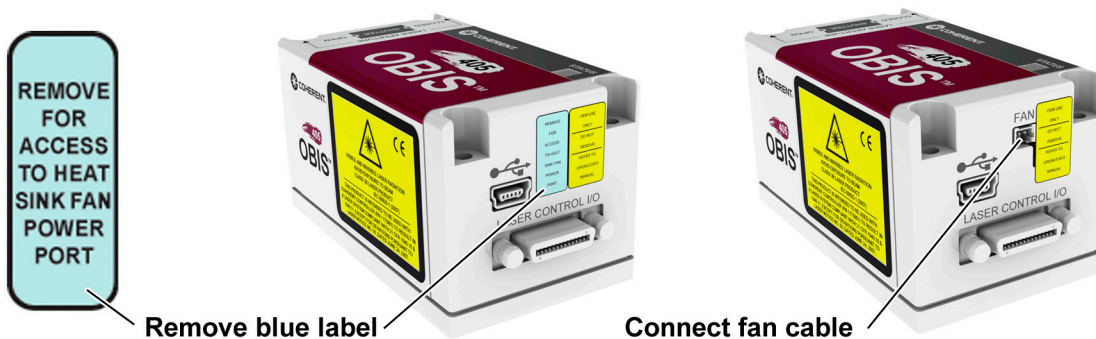


*Figure 3-13. Connecting Power*

The Coherent OBIS laser system includes a power supply (which has a power ON indicator). For more information and specifications about the power supply, refer to “Power Supply for OBIS Laser or OBIS Remote” (p. 2-12).

**Adding Optional Fan Power**

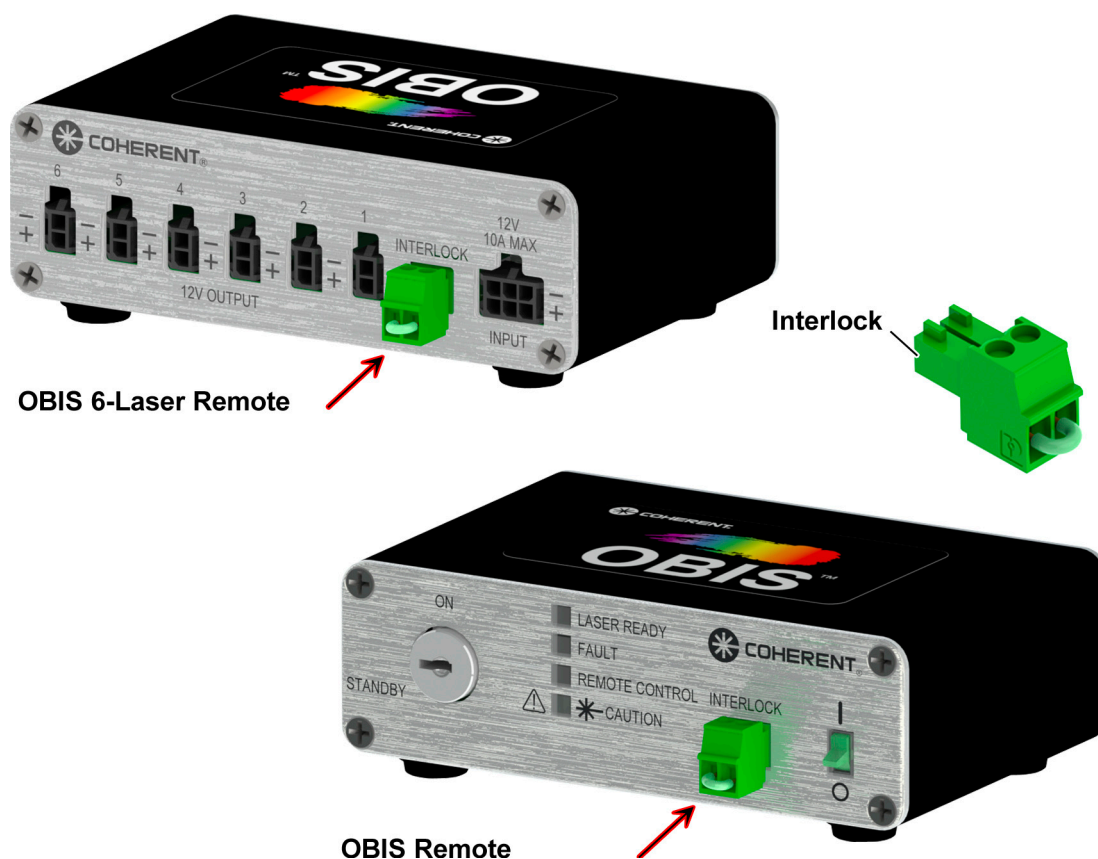
1. Remove the blue label that covers the FAN connection. *Do not remove the yellow label next to it.*
2. Connect the fan cable to the laser head.



*Figure 3-14. Adding Optional Fan Power to the Laser Head*

## Connecting the Interlock

For OBIS Remote interlock details and specifications, refer to “Interlock Control” (p. 2-23). For OBIS 6-Laser Remote interlock details and specifications, refer to “Interlock Control” (p. 2-32).



**Figure 3-15. Connecting the Interlock**

## Connecting Optional USB/RS-232

It is possible to control laser power or other parameters remotely via a USB or RS-232 connection. For details about enabling this feature, refer to “Connecting USB/RS-232 for Remote Control” (p. 5-1). For general information about remote control, refer to “USB and RS-232 Remote Control” (p. 4-10). For information about using remote control through your computer, refer to the Coherent OBIS Connection software Help file.

## Heat Sink Requirement

It is imperative that the OBIS laser head be adequately heat sunk; otherwise it will overheat and shut down. Figure 3-16 shows the heat dissipation of the OBIS laser head for given baseplate temperatures. The graph shown in Figure 3-17 helps determine the heat sink thermal impedance requirement.

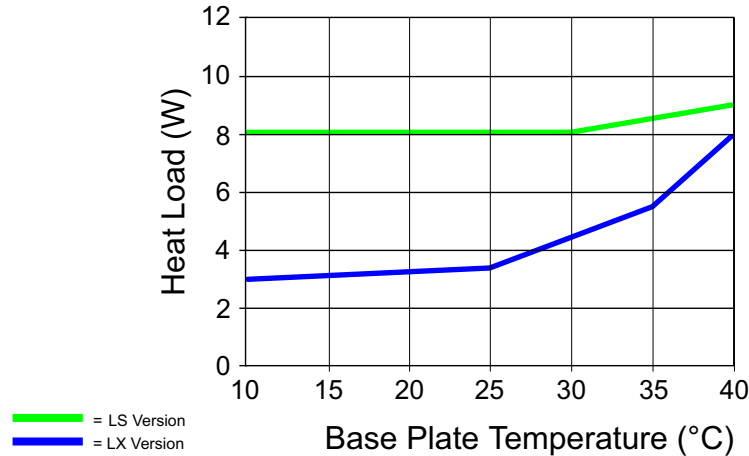


Figure 3-16. Measured Thermal Dissipation Data of the OBIS Laser Head



**NOTICE!**

Pyrolytic graphite pads can be used to improve thermal contact between the baseplate and the heat sink. Many extruded heat sinks are warped and the mounting surface should be milled flat (within < 0.05 mm over the mounting surface). Coherent recommends *against* the use of thermal grease.

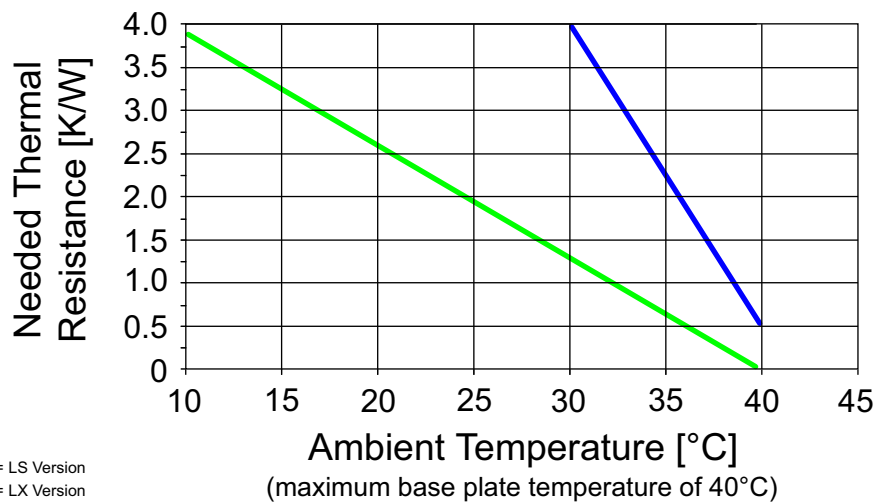


Figure 3-17. Maximum Thermal Impedance of Heat Sink Needed to Cool OBIS Laser

## SECTION FOUR: OPERATION

In this section:

- Introduction (this page)
- Hardware setup (this page)
- CW operation (p. 4-2)
- Pulsed operation (p. 4-5)
- USB and RS-232 remote control (p. 4-10)

### Introduction

The OBIS laser system has five operating modes:

- Continuous-Wave Constant Power (CWP)
- Continuous-Wave Constant Current (CWC) (LX version only)
- Pulsed Analog Modulation
- Pulsed Digital Modulation
- Pulsed Mixed Modulation (analog and digital)



---

#### ***NOTICE!***

**The system is shipped in CWP mode. Operating in other modes requires user initiation, which has to be performed by USB or RS-232 remote control from a computer running either OBIS Connection software or terminal console application software (for example, Windows HyperTerminal).**

---

### Hardware Setup

Normal operation of the OBIS Remote assumes the following initial configuration steps have been completed:

1. Appropriate laser safety control measures have been set up—refer to “Section One: Laser Safety” (p. 1-1) for laser safety information.
2. The laser head has been mounted with the proper heat sink and torque specifications—refer to “Installing the Optional Heat Sink” (p. 3-2) for heat sink and torque requirements.

3. The SDR interface cable has been connected between the laser head and the OBIS Remote.
4. The main power switch on the OBIS Remote is in the OFF ("0") position.
5. The key switch on the OBIS Remote is in the OFF position.
6. The interlock jumper on the OBIS Remote is closed.
7. The power supply cable is connected to the OBIS Remote. (there is no need to connect the power supply cable to the laser head).

## CW Operation

### CW Constant Power Operation



---

**NOTICE!**

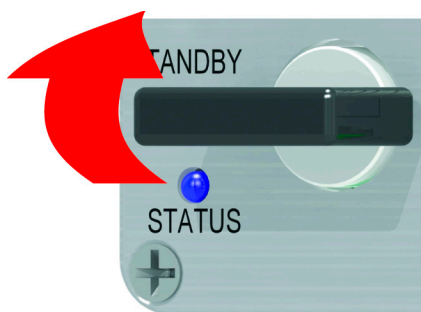
**The OBIS laser system is shipped in CWP mode. The laser emission is active after the OBIS Remote keyswitch is set to the ON position.**

---

1. Toggle the OBIS Remote power switch to the ON position. The status LED on the laser head flashes green at 2.5 Hz, showing that the laser head is in the warm-up mode.



2. Wait until the status LED on the laser head turns blue. The laser head finishes its warm-up mode and goes into Standby mode.



3. Turn the OBIS Remote keyswitch to the ON position to initiate laser emission. Laser emission occurs after the keyswitch is set to the ON position. The status LED on the laser head turns white and remains white when the

laser emission is ON.

4. After safe laser beam control is ensured, move the laser shutter to the OPEN position, as indicated on the laser head top label.
5. Changing the output laser power requires USB or RS-232 remote control from a host computer running OBIS Connection software or a terminal console application (for example, Windows HyperTerminal). For OBIS Connection instructions, start the software and then refer to the integrated Help file. For information on available commands and queries, refer to “Commands and Queries” (p. 7-8).

**Table 4-1. OBIS LS Modulation Types**

Modulation Feature	OBIS LS versus OBIS Firmware 1.X versus OBIS Firmware 2.X		
	OBIS LS	OBIS Firmware 1.X	OBIS Firmware 2.X
Constant power, power control <sup>a</sup>	CW Power	CW Power	CW: Power
Constant Current, current control <sup>b</sup>	CW Current	CW Current	CW: Current
Digital Modulation, current control	Digital Modulation	Digital Modulation	Digital: Current
Digital Modulation, slow, power control	N/A	N/A	Digital: Power
Analog Modulation, power control	Analog Modulation	Analog Modulation	Analog: Power
Mixed Modulation, slow, power control	N/A	N/A	Mixed: Power
Mixed Modulation, current control	Mixed Modulation	Mixed Modulation	Mixed: Current
There is a tradeoff between power and current modes. <i>Power modes</i> are more accurate, with small modulation overshoots, but are slower to modulate. <i>Current modes</i> have a larger overshoot but allow faster modulation.			

a. Power Control = Light Regulation

b. Current Control = Current Regulation



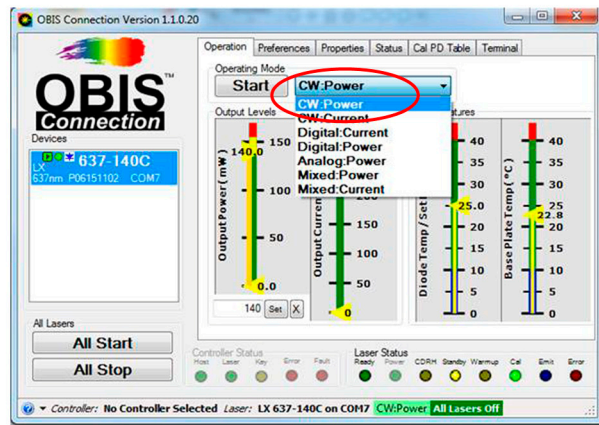
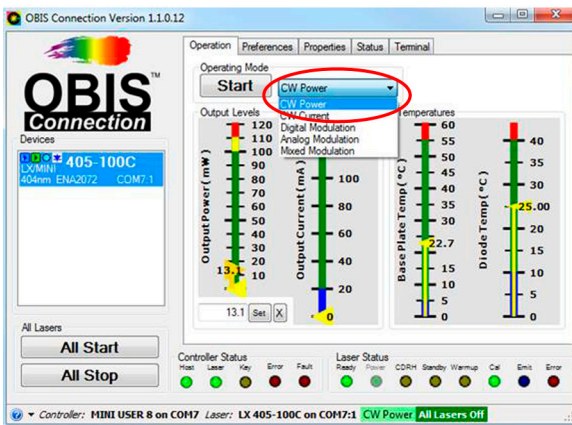
## CW Constant Current Operation

(LX systems only) Operating the OBIS laser at constant current mode requires initializing via OBIS Connection software or Windows HyperTerminal. For remote control setup, refer to “USB and RS-232 Remote Control” (p. 4-10). Note the current level in constant current mode is indirectly set by moving the Power bar.

1. Set up the OBIS laser system as described under “CW Constant Power Operation” (p. 4-2).
2. In the OBIS Connection program, choose *CWC* mode in the *Operating Mode* drop-down box.
3. Clicking on the tag will activate the drop-down menu, which lists the different options for modulation.

OBIS LS/OBIS LX Firmware 1.x

OBIS LX Firmware 2.X



4. Click the **Start** button. The laser will turn on after a 5-second delay.
5. Slide the Power bar to set the desired current value shown on the current bar.

If you are using Windows HyperTerminal or other remote control program, refer to “OBIS Communications Through HyperTerminal” (p. 6-7).

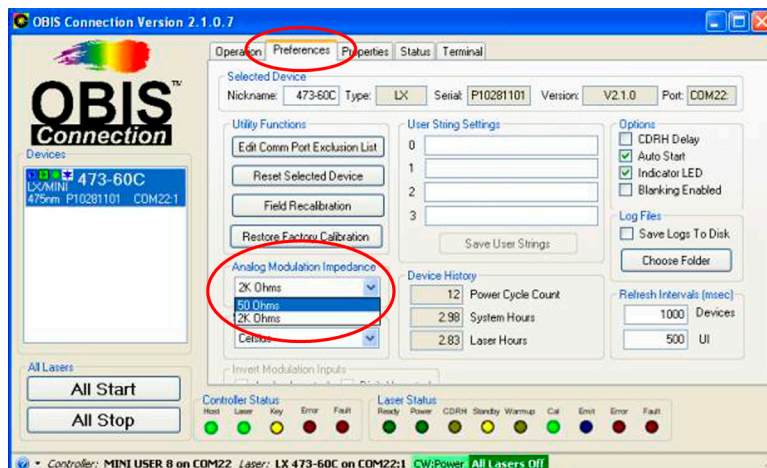
## CW Operation by Analog Control

The OBIS laser system provides the capability to control the output power with an external DC voltage source. To initiate this operation mode:

1. Start the OBIS Connection program.
2. Select *Analog Modulation* in the *Operating Mode* drop-down box.



- Select the Analog Modulation Impedance (*2K Ohms* or *50 Ohms*) from the Preferences tab. This selects the impedance of the remote.



- Apply the analog voltage ( $\leq 5V$ ) through the analog SMB connector on the back of the OBIS Remote. The laser power can be varied from minimum to 100%, with a corresponding analog voltage from 0 to 5V. Maximum bandwidth of the analog control is 1 MHz for direct diode (LX) system and 100 kHz for the OPSSL (LS) system. For detailed specifications of the analog modulation, refer to the OBIS data sheet.




---

**NOTICE!**

**When operating in this mode, the optical power feedback loop is disabled. (LX system only)**

---

## Pulsed Operation

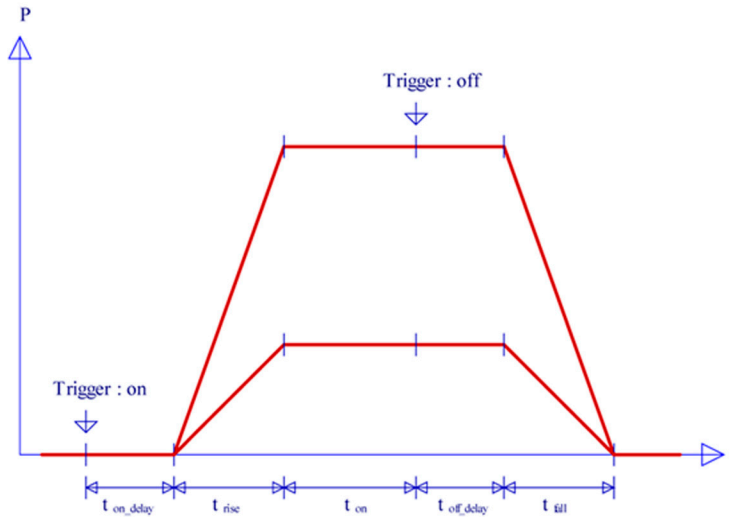
The OBIS laser system provides the capability of CW or pulsed laser emission. The pulsed output must be controlled with external analog or digital signals (or both). The OBIS Remote analog SMB connector provides analog modulation to 1 MHz (direct diode LX system) or 100 kHz (OPSSL LS system); the OBIS Remote digital SMB connector provides digital TTL modulation to 100 MHz (direct diode LX system) or 50 kHz (OPSSL LS system). For actual wavelength and power performance values, refer to the product data sheet specific to your laser.

## Analog Modulation

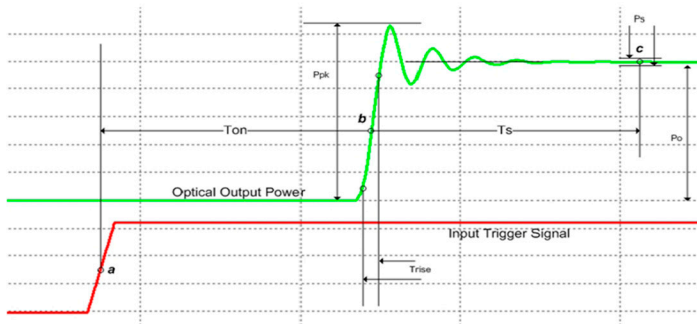
The OBIS laser system requires a remote computer to initiate analog modulated pulse operation. In the OBIS Connection program, choose *Analog Modulation* from the *Operating Mode* drop-down box. If you are using Windows HyperTerminal or other remote control program, refer to "OBIS Communications Through HyperTerminal" (p. 6-7).

## Modulation Waveform Definitions

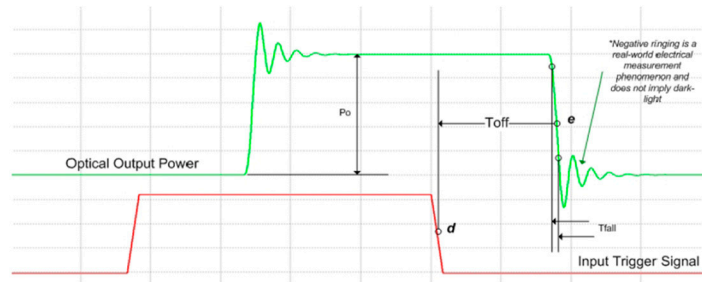
The following three figures show a typical modulation pulse, including the maximum power and the minimum power output pulses.



$t_{on,delay}$  = pulse delay time  
 $t_{rise}$  = pulse rise time  
 $t_{on}$  = pulse on time  
 $t_{fall}$  = pulse fall time

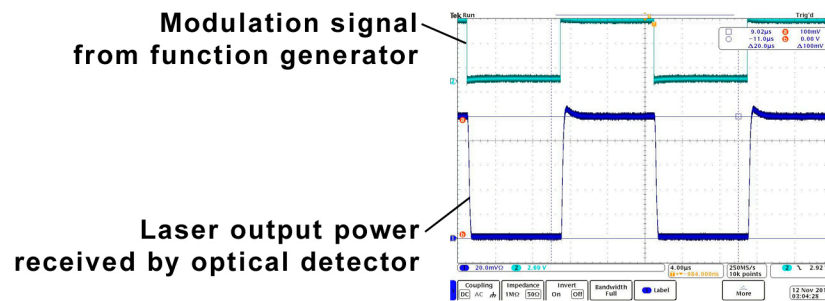


$a$  &  $d$  = 50% of input trigger signal  
 $b$  &  $e$  = 50% of  $P_o$   
 $T_{on} = T(b) - T(a)$   
 $T_{off} = T(d) - T(e)$   
 $T_{rise} = T(0.1 * P_o) - T(0.9 * P_o)$   
 $T_{fall} = T(0.9 * P_o) - T(0.1 * P_o)$   
 Settling time  $T(s)$  to 1% =  $T(c) - T(b)$ ; where  $P_s/P_o * 100 = 1\%$   
 $Overshoot(\%) = (P_{pk} - P_o)/P_o * 100$



$a \ \& \ d = 50\% \text{ of input trigger signal}$   
 $b \ \& \ e = 50\% \text{ of } P_o$   
 $T_{on} = T(b) - T(a)$   
 $T_{off} = T(d) - T(e)$   
 $T_{rise} = T(0.1 * P_o) - T(0.9 * P_o)$   
 $T_{fall} = T(0.9 * P_o) - T(0.1 * P_o)$   
 Setting time  $T(s)$  to 1% =  $T(c) - T(b)$  ; **where  $P_s/P_o * 100 = 1\%$**   
 $Overshoot(\%) = (P_{pk} - P_o)/P_o * 100$

The figure below shows typical waveforms under analog modulation. In this example, the analog signal is a 0 to 5V, 50 kHz, square wave.



**Figure 4-1. Oscilloscope Traces of OBIS Laser Analog Modulation**

## Digital Modulation

The OBIS laser system requires a remote computer to initiate digital pulse operation. In the OBIS Connection program, choose *Digital Modulation* from the *Operation Mode* drop-down box. If you are using Windows HyperTerminal or other remote control program, refer to “OBIS Communications Through HyperTerminal” (p. 6-7).

Typical waveforms and rise/fall time under digital modulation are shown below. In this example, the digital signal is a 1.1 to 3.3V, 10 MHz, square wave.

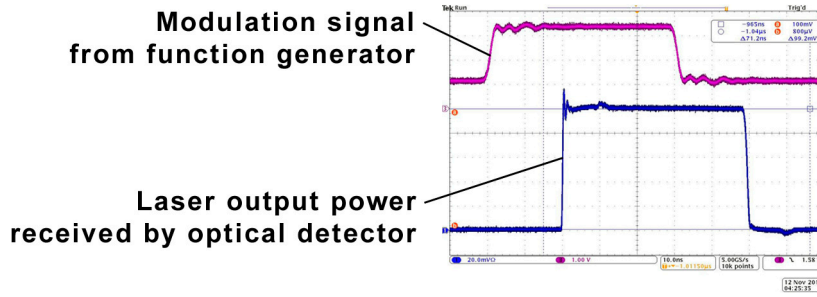


Figure 4-2. Oscilloscope Traces of OBIS Laser Digital Modulation

The following figure shows the typical rise and fall behavior of OBIS digital modulation. The oscilloscope trace is set to 2 nsec/div.

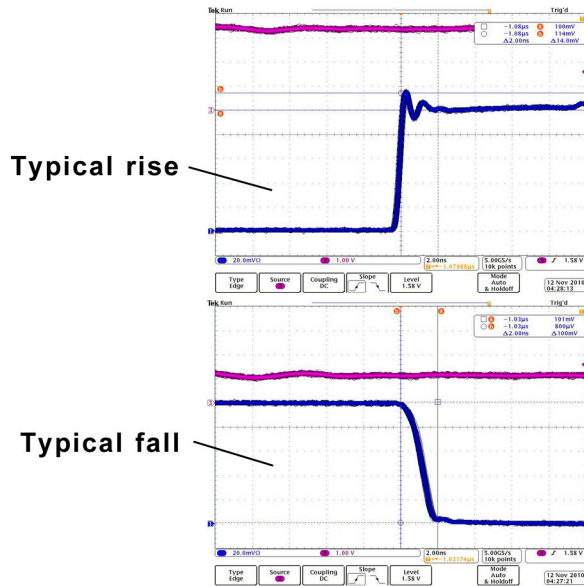


Figure 4-3. Typical Rise and Fall Behavior of OBIS Laser Digital Modulation

### Mixed Modulation

The OBIS laser system can be modulated by both analog and digital signals at the same time. To initiate this mixed modulation mode, in the OBIS *Connection program*, choose *Mixed Modulation* from the *Operating Mode* drop-down box. If you are using Windows HyperTerminal or other remote control program, refer to “OBIS Communications Through HyperTerminal” (p. 6-7).

An example of mixed modulation is shown below. In this example, the analog signal is a 0 to 5V, 1 kHz triangle wave and the digital signal is a 1.1 to 3.3V, 30 kHz, square wave.

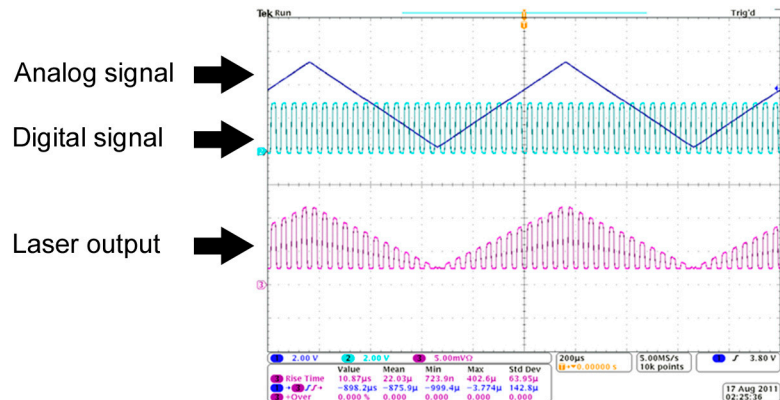


Figure 4-4. Oscilloscope Traces of OBIS Laser Mixed Modulation

Blanking can be enabled/disabled through OBIS Connection, under the Preferences tab

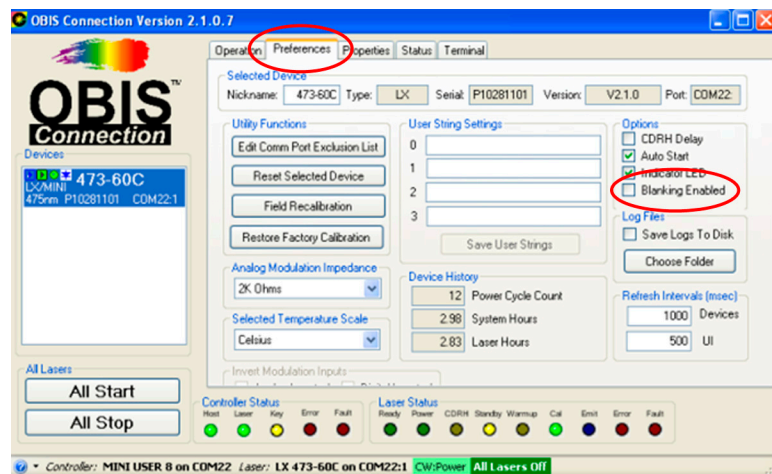


Figure 4-5. Enabling/Disabling Blanking through OBIS Connection

Blanking is used to turn the diode completely off. If not used, the diode will remain on but will be below lasing threshold.

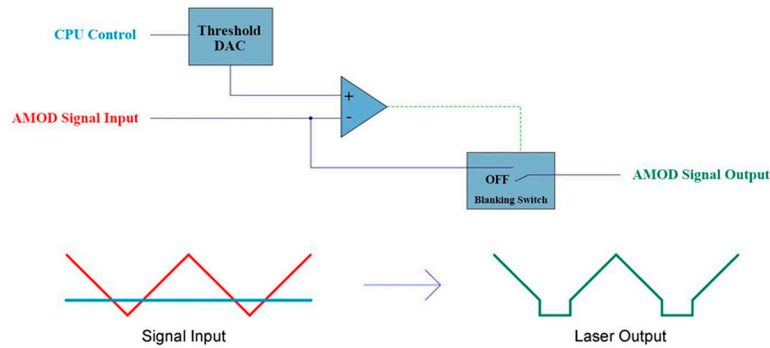


Figure 4-6. OBIS LX Analog Modulation Blanking Circuit Diagram

## USB and RS-232 Remote Control

The OBIS laser system provides remote control capability through USB or RS-232. Note that:

- USB and RS-232 use the same syntax, commands and queries.
- When both USB and RS-232 are connected to the OBIS Remote, the USB overrides the RS-232.
- The USB connection on the laser head (without a OBIS Remote) is for OEM users only and is *not* CDRH compliant. Its use is not discussed in this manual.

The OBIS uses a standard DB-9 style RS-232 connection. Connect a standard serial cable from the computer to the back of the OBIS Remote. Table 4-2 shows the RS-232 pin-outs and Table 4-3 shows the RS-232 communication settings.

Table 4-2. RS-232 Pin Connections

Pin	Signal	Pin	Signal
1	DCD (Data Carrier Detect)	6	DSR (Data Set Ready)
2	Rx (Receive)	7	RTS (Request to Send)
3	Tx (Transmit)	8	CTS (Clear to Send)
4	DTR (Data Terminal Ready)	9	Unused
5	GND (Ground)		

Table 4-3. RS-232 Communication Settings

Baud	115200
Parity	None
Data Bits	8
Stop Bits	1
Flow Control	None

**Table 4-4. Factory Default Settings**

Setting	Description
OFF	Command prompt
ON	Command handshake
ON	Laser emission auto start
ON	CDRH delay
ON	Laser head warm-up
Nominal power	Output power level
0 watts	Minimum power output limit
110% nominal power	Maximum power output limit
CW constant power (CWP)	Operating mode
25°C	Laser diode set temperature <sup>a</sup>
ON	Laser head status LED
ON	Laser head thermoelectric cooler <sup>b</sup>
50Ω	OBIS Remote analog input impedance
Degrees Celsius	Unit for all temperature settings

a. LX version only

b. LX system only

**Table 4-5. Status Code Bit Definitions (Sheet 1 of 2)**

Bit Code	Mask Value	Bit Label	Description	
			OBIS Remote	Laser Head
0	00000001	Laser Fault	Logical OR from laser	Laser head fault
1	00000002	Laser Emission	Logical OR from laser	Laser emission status
2	00000004	Laser Ready	Logical OR from laser	Laser ready status
3	00000008	Laser Standby	Logical OR from laser	Laser standby status
4	00000010	CDRH Delay	Logical OR from laser	Laser CDRH delay status
5	00000020	Laser Hardware Fault	Logical OR from laser	Hardware related fault
6	00000040	Laser Error	Logical OR from laser	Laser error is queued
7	00000080	Laser Power Calibration	Logical OR from laser	Laser power is within factory calibration specification
8	00000100	Laser Warm Up	Logical OR from laser	Laser warm-up status
9	00000200	Laser Head Noise	Logical OR from laser	Noise level is over 30
10	00000400	External Operating Mode	Logical OR from laser	External operating mode is selected
...	...	...		
25	02000000	Controller Standby	Key switch is in “STANDBY” position	Always 0
26	04000000	Controller Interlock	“INTERLOCK” is open	Always 0
27	08000000	Controller Enumeration	Laser head has been enumerated	Always 0

**Table 4-5. Status Code Bit Definitions (Sheet 2 of 2)**

Bit Code	Mask Value	Bit Label	Description	
			OBIS Remote	Laser Head
28	10000000	Controller Error	OBIS Remote error flag	Always 0
29	20000000	Controller Fault	OBIS Remote fault status	Always 0
30	40000000	Remote Active	A remote host is connected	Always 0
31	80000000	Controller Indicator	Status word is from OBIS Remote	Always 0

**Table 4-6. Error Codes and Description Strings**

Error Code Number	Quoted Error String	Error Description
-400	“Query Unavailable”	Broadcast of query is prohibited.
-350	“Queue overflow”	Error queue is full.
-321	“Out of memory”	Internal memory is exhausted.
-310	“System error”	Unexpected/unrecoverable hardware or software fault.
-257	“File to open not named”	The file open is not possible because the file has not been named.
-256	“File does not exist”	The specified file does not exist.
-241	“Device Unavailable”	Command was sent to a device that is not available.
-221	“Settings conflict”	Command not executed due to current device state.
-220	“Invalid parameter”	The command or query parameter is invalid.
-203	“Command protected”	Command is password protected.
-200	“Execution error”	Command is out of order.
-109	“Parameter missing”	No or fewer parameters were received.
-102	“Syntax error”	Unrecognized command or data type was encountered.
-100	“Unrecognized command/query”	The command or query is not recognized.
0	“No error”	No error.
500	“CCB fault”	A Coherent Connection bus error was encountered.
510	“I2C bus fault”	A device internal I2C bus error was encountered.
520	“Controller Time Out”	No response was received within 0.7 seconds from a slave device and the message was resent three times by the controller.
900	“CCB Message Timed Out”	Coherent Connection Bus Msg Timed Out after 3 retries.

**Error -400** is raised when sending a query as a broadcast message. Queries may not be broadcast.

**Error -350** is raised when the error queue becomes full. Non-“Queue overflow” errors are replaced by “Queue overflow” errors when there is exactly one available storage location available in the error queue. No additional errors are added to the error queue if the error queue is full.



**Error -321** is raised when there is an internal memory-related error. This error may be caused by exhaustion of the memory heap, overflow of a fixed memory buffer, or a similar type of problem.

**Error -310** is raised when the device firmware detects an unexpected or unrecoverable error. This error condition includes unrecoverable hardware faults.

**Error -257** is raised when an attempt to open a file is made without specifying a file name.

**Error -256** is raised when an attempt is made to open a file that does not exist.

**Error -241** is raised when sending a message to a device that is not currently available.

**Error -221** is raised when a command is received that is at odds with the current device settings.

**Error -220** is raised when an invalid parameter has been specified.

**Error -203** is raised when an attempt to execute a password-protected command is made when in user mode.

**Error -200** is raised when an order-dependent command sequence is issued out of order (for example, trying to read from a file before the file has been opened).

**Error -109** is raised when there are no or fewer parameters for received command or query.

**Error -102** is raised when command or data type is not recognized.

**Error -100** is raised when the device receives an unrecognized command or query. This is a generic syntax error for devices that cannot detect more specific errors.



## SECTION FIVE: COMPUTER CONTROL

In this section:

- Connecting USB/RS-232 for remote control (this page)
- USB head connections (this page)
- USB drivers (this page)
- Installing the OBIS software (p. 5-2)

### Connecting USB/RS-232 for Remote Control

(optional) The OBIS laser system is now ready to use in its default constant power operation; however, to control the laser power or other parameters, remote controlling via USB or RS-232 to a computer is required. In addition, user initiation is required by remote control to operate and control the laser in other modes.

Connecting a USB or RS-232 cable from a computer to the OBIS Remote is straight forward. The USB cable is included in the OBIS laser package. The RS-232 cable is the standard PC serial cable (not included in the laser package). For remote control details, refer to “USB and RS-232 Remote Control” (p. 4-10).



**Figure 5-1. Connecting a USB or RS-232 Cable**

### USB Head Connections

- Standard Mini-USB connection
- USB 2.0 communication

### USB Drivers

OBIS USB drivers are available on the OBIS flash drive, as well as on-line at [www.Coherent.com](http://www.Coherent.com)

## **System Requirements**

- CPU: Intel® Pentium 4
- System RAM: 256 MB (512 MB recommended)
- Free hard disk space: 45 MB
- Operating systems (32- or 64-bit):
  - Microsoft® Windows XP® (with Service Pack 2)
  - Windows Vista®
  - Windows 7®
- Port: USB (1.1 or 2.0), or RS-232

## **Installing the OBIS Software**



To install the OBIS software:

1. Close all programs.
2. Insert the OBIS flash drive into a USB port on your computer.
3. Double-click the *OBIS\_Connection\_Setup.exe* file to start the installation process.
4. Follow the on-screen instructions.

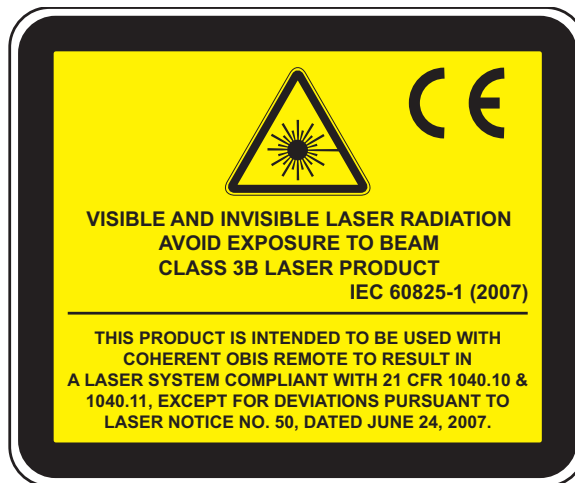
## SECTION SIX: ADVANCED PROCEDURES

In this section:

- CDRH feature (this page)
- Installing and operating the OEM laser head only (p. 6-4)
- System standby and sleep mode (p. 6-6)
- OBIS communications through HyperTerminal (p. 6-7)

### **CDRH Feature**

The OBIS is shipped as a CDRH-compliant laser system. The CDRH-required delay of approximately five seconds occurs between a laser-ready condition and emission of laser light. This delay allows the user to take appropriate safety precautions prior to laser emission. Each time the laser is turned off, the delay is applied



## Disabling CDRH Procedure



---

### CAUTION!

This operation defeats the safety controls required by the appropriate regulatory agencies. With the use of these commands, the customer assumes all responsibility for safety and proper compliance to CDRH 21 CFR 1040 and IEC60825-1.

The ability to change the state of the CDRH-required delay requires remote communication to the OBIS laser system via USB or RS-232.

The CDRH setting is stored in memory.

---

This requires the user to remotely control the OBIS system. For remote control setup, refer to “USB and RS-232 Remote Control” (p. 4-10).

1. Use the “SYSTem:CDRH OFF” command to defeat the CDRH-required delay.
2. The current CDRH-required delay status can be interrogated by sending with the “SYSTem:CDRH?” command.
3. The CDRH-required delay feature can be restored by using the “SYSTem:CDRH ON” command.

CDRH Delay can be enabled/disabled through OBIS Connection, under the Preferences tab.

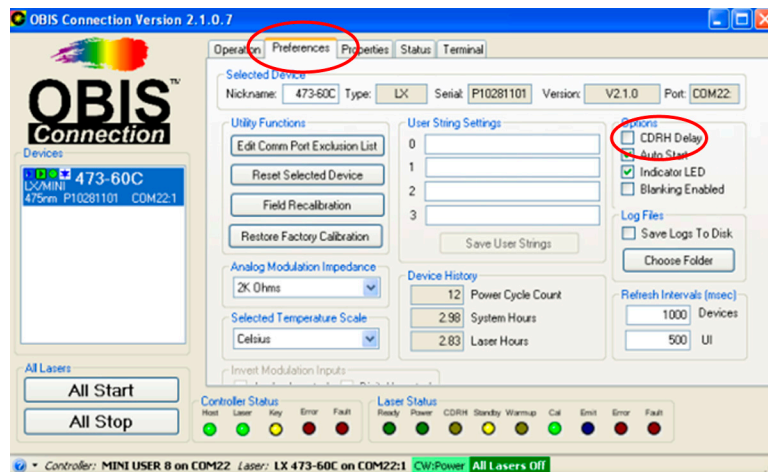


Figure 6-1. Enabling/Disabling CDRH Delay through OBIS Connection

## Enabling Auto Start



### CAUTION!

Using an OBIS laser without the Remote is *not* CDRH compliant. The customer assumes all responsibility for safety and proper compliance to CDRH 21 CFR 1040 and IEC60825-1.

The OBIS Remote has an Auto Start switch which is beneath a yellow label on the back panel (refer to the following figure). By default this switch is in the OFF position. To access the Auto Start switch, remove the yellow label.



Figure 6-2. OBIS Remote Auto Start Switch Location

Auto Start can be enabled/disabled through OBIS Connection, under the Preferences tab.

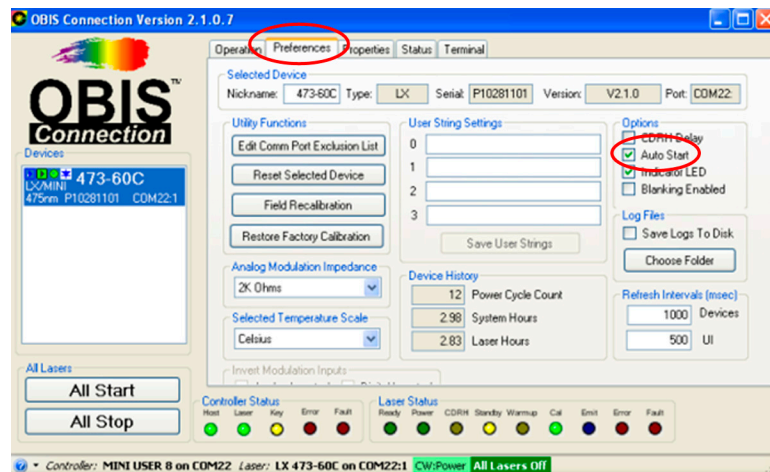


Figure 6-3. OBIS LX Auto Start

Table 6-1 lists the details on how the system starts up.

**Table 6-1. Auto Start (at Moment of Power On)**

		<b>Auto Start (at moment of power on)</b>	
		<b>Off</b>	<b>On</b>
Key Switch	OFF	Light emission does not start. Sending digital command via RS-232 or USB, or analog interface cannot start light emission. Key switch needs to be turned to the “ON” position to start light emission.	Light emission does not start. Sending digital command via RS-232 or USB, or analog interface cannot start light emission. Key switch needs to be turned to the “ON” position to start light emission.
	ON	Light emission does not start automatically. Sending according digital command via RS-232 or USB, or analog interface starts light emission when warm-up is finished.	Light emission starts automatically when warm-up is completed. Sending according digital command via RS-232 or USB, or analog interface can control light emission.

## Installing and Operating the OEM Laser Head Only




---

**CAUTION!**

**OBIS laser head only operation does not have the interlock feature and thus is not CDRH-compliant. The user assumes all responsibility for safety and proper compliance to CDRH 21 DFR 1040 and IEC60825-1.**

---

The OBIS laser head can be operated without the OBIS Remote by connecting the USB cable and the power cable to the back of the laser head. Keep the following in mind:

- Without the OBIS Remote, only CW operation—constant power (LS systems) or constant current—is possible.
- Either OBIS Connection software or terminal console application software (for example, Windows HyperTerminal) can be used for remotely controlling laser head only operation.

Installing the OEM laser head consists of the following steps:

1. Connecting power cable and the optional USB cable (p. 6-5)
2. Adding optional fan power (p. 6-5)



## Connecting Power and the Optional USB Cable

1. Remove the yellow label that covers the POWER connection. *Do not remove the blue label next to it.*
2. Connect the power cable and the optional USB cable (if desired).

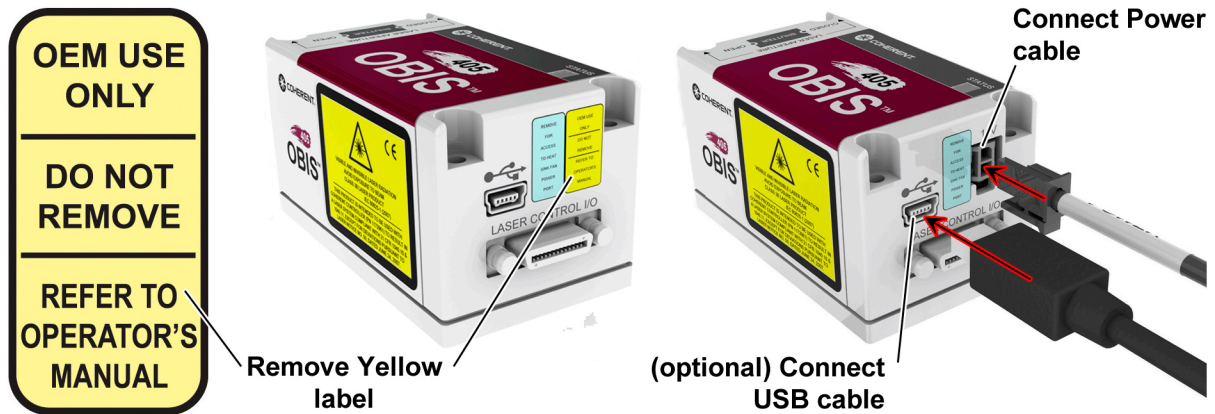


Figure 6-4. Connecting Power and the Optional USB Cable

## Adding Optional Fan Power

1. Remove the blue label that covers the FAN connection. *Do not remove the yellow label next to it.*
2. Connect the fan cable to the laser head.

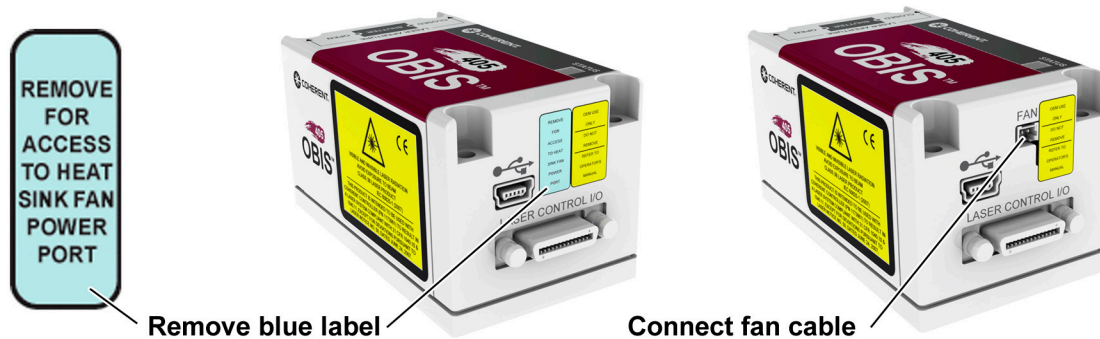


Figure 6-5. Adding Optional Fan Power to the Laser Head

For information on the SDR connector and SDR cable, refer to Table 2-5 (p. 2-18) and Table 2-6 (p. 2-19).

## Mounting Hardware Recommendation

4-40 x 1 3/8 in. with small pattern flat washer or M3 x 35 mm with small pattern washer (supplied).

## Power Supply Requirements

12VDC @ 2A

If user-supplied, the DC power supply has to meet the following requirements:

- Power > 20W
- Ripple < 5% peak-to-peak
- Line regulation < 0.5%.

## System Standby and Sleep Mode

For users requiring intermittent use of the OBIS laser system, two levels of non-lasing conditions are offered:

- “Standby” represents the thermoelectric cooler (TEC), maintaining constant diode temperature with the laser diode off.
- “Sleep Mode” represents that both TEC and the laser are off.

With factory default settings, the OBIS laser will be in the “Standby” condition after the system is turned on and the warm-up procedure has been completed.

To initiate the “Sleep Mode” condition, use the “SOURce:TEMPerature:ARPobe OFF” command. This will turn off the TEC in the laser head. To go back to the “Standby” condition, use the “SOURce:TEMPerature:ARPobe ON” command to switch on the TEC and wait for the warm-up procedure to be completed.

---

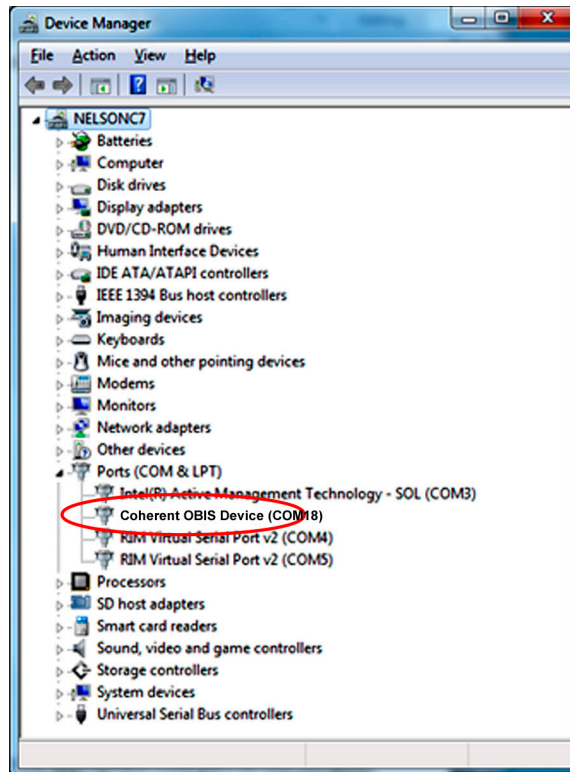
**The “Sleep Mode” is only possible for the OBIS direct-diode system and not available for the OPSL system.**

---

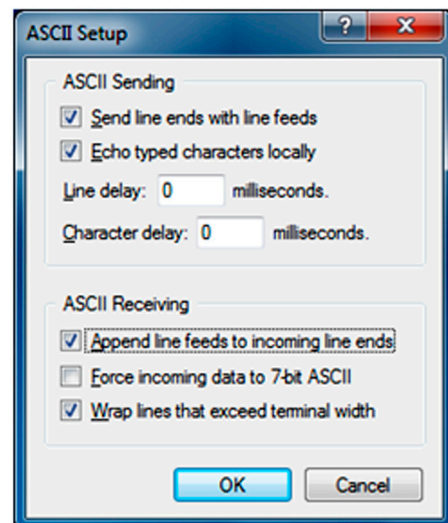
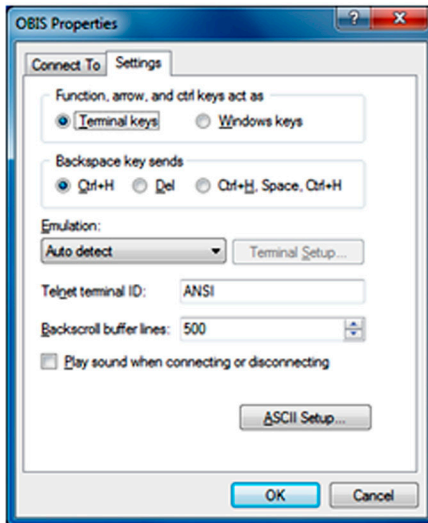
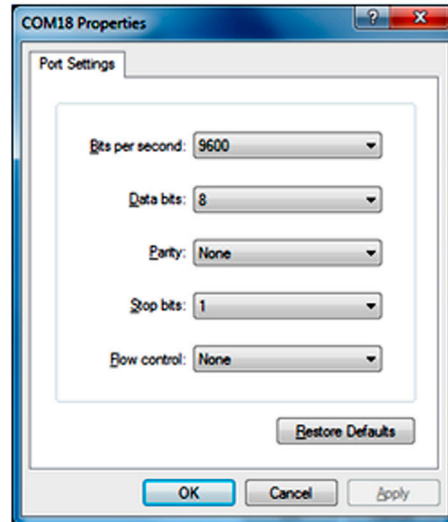
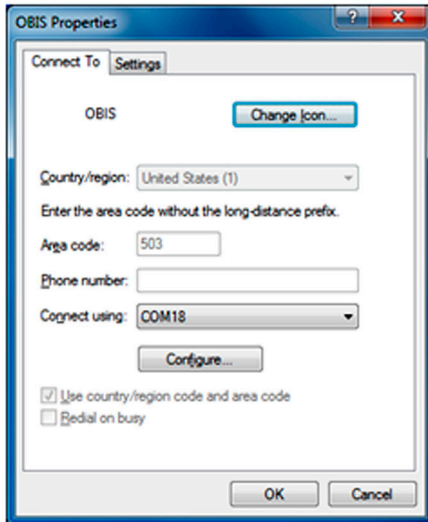
## OBIS Communications Through HyperTerminal

1. Connect the OBIS to a computer using the USB port and then turn on the OBIS.

The computer will recognize the OBIS as a COM port on the computer. To determine which COM port has been assigned to the OBIS, open *Device Manager* on the computer and look for the *OBIS Device* under the *Ports (COM & LPT)* heading.

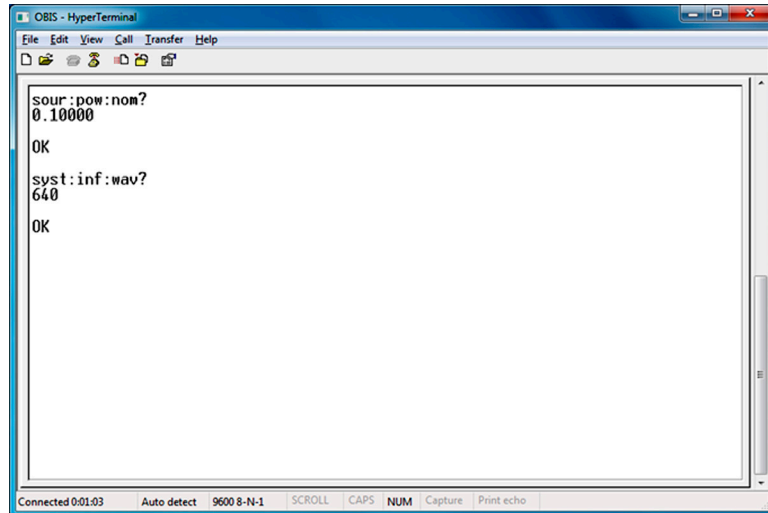


2. Open HyperTerminal and create a file name for the new connection. Select the appropriate COM port that has been assigned to the OBIS (see Step 1, above) and follow the recommended HyperTerminal menu settings shown below. Note that the exact port settings are not critical since this is a virtual COM port connection.



- Go to the HyperTerminal main window and activate the connection by pressing the **Call** button.

In the following example, query commands were used to check the nominal power level and wavelength of the laser.



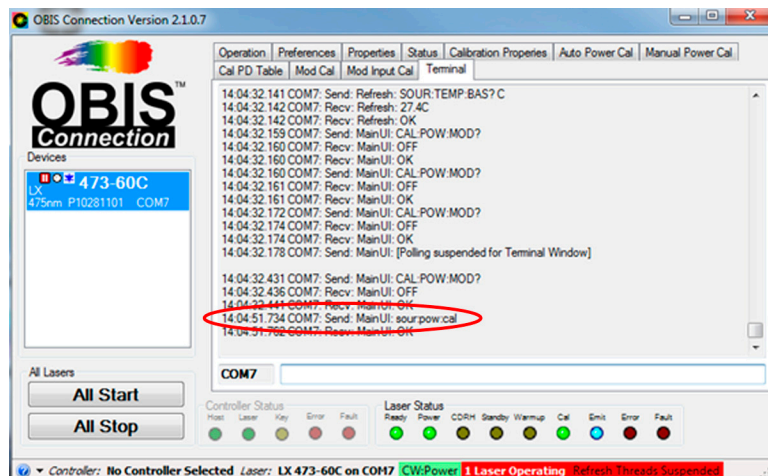

---

For a list of commands you can use to communicate with the laser, refer to “Section Seven: Host Interface” (p. 7-1).

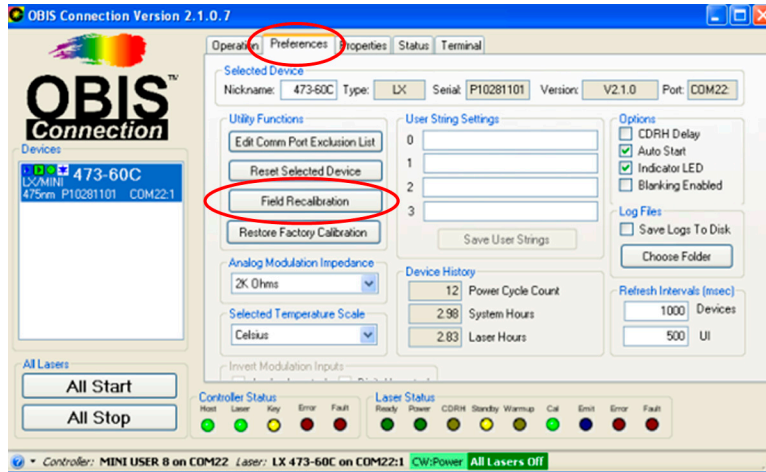
---

## OBIS LX Firmware 2.X with OBIS Connection 2.x

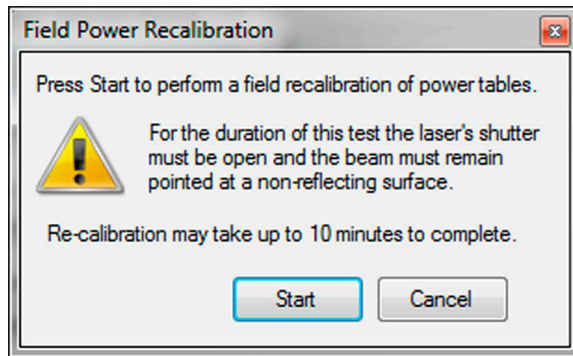
The new OBIS 2.x laser with the OBIS Connection 2.x firmware has a calibration command. The feature needs to be utilized whenever digital modulation is used. Below is the terminal screen with the CAL command implemented. The procedure takes approximately two minutes to complete. The status LED on the OBIS blinks **RED** while calibrating the laser and turns **BLUE** when the process is completed.



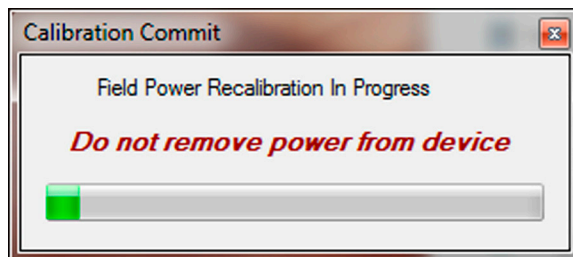
The OBIS can also be re-calibrated through the OBIS Connection. Under the Preferences Tab you will find the Field Calibration button. Activating this button will start the recalibration process.



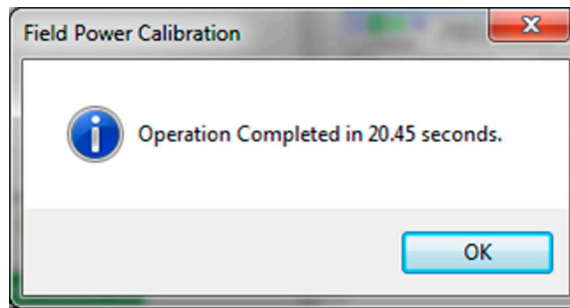
Activating the Field Calibration brings up this dialog box.



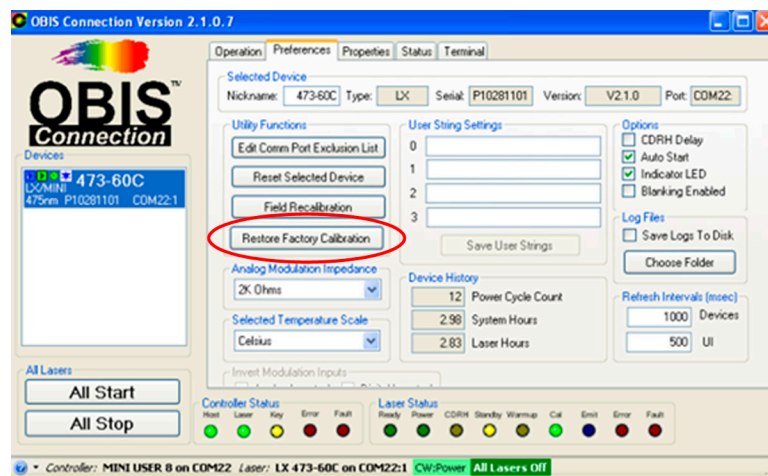
The process takes less than 10 minutes. After pushing the start button, you will see the progress dialog box.



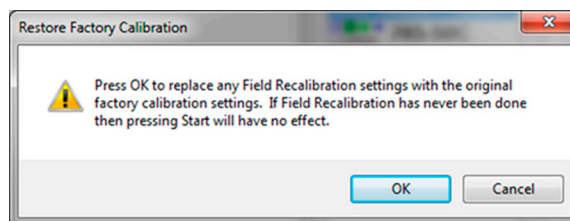
When completed, you see the completed dialog box along with how long it took. This is a typical value.



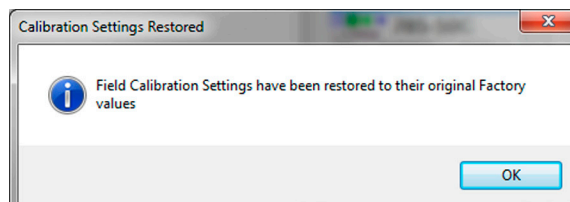
To restore the original factory calibration settings, activate the button in OBIS Connection.



After activating the restore command, the following dialog will appear.



Pressing OK will start the replacement process. When completed, the following dialog box appears and the recalibration is finished.







## SECTION SEVEN: HOST INTERFACE

In this section:

- Host command quick reference (this page)
- Message considerations (p. 7-3)
- Commands and queries (p. 7-8)
- Controls and queries (p. 7-26)




---

### **NOTICE!**

**When a command is sent to the OBIS system, the parameter for the command is stored in internal persistent memory, which has a logic cell life of 1 million cycles for the laser head or 10 thousand cycles for the OBIS Remote. The cell life sets the limits for repetitive commands sent to the OBIS system.**

**This only applies to commands and not queries.**

---

### **Host Command Quick Reference**

The following table gives a brief description of all host commands and queries. For detailed information about a specific command or query, go to the page referenced in the right-hand column.

*Table 7-1. Host Command Quick Reference (Sheet 1 of 3)*

Command	Description	Page No.
<b>Mandatory Commands/Queries</b>		
<i>IEEE-488.2</i>		
*IDN?	Gets the laser head's identification string	7-9
*RST	Causes a device to warm boot if implemented	7-9
*TST?	Runs a laser self-test procedure, if implemented	7-9
<i>Session Control</i>		
SYSTem:COMMunicate:HANDshaking	Toggles the system handshaking	7-10
SYSTem:COMMunicate:HANDshaking?	Queries the system handshaking	7-10
SYSTem:COMMunicate:PROMpt	Toggles the system command prompt	7-10
SYSTem:COMMunicate:PROMpt?	Queries the system command prompt	7-10
SYSTem:AUTostart	Enables or disables the laser auto start feature	7-10

**Table 7-1. Host Command Quick Reference (Sheet 2 of 3)**

<b>Command</b>	<b>Description</b>	<b>Page No.</b>
SYSTem:AUTostart?	Queries the laser auto start feature	7-10
SYSTem:INFormation:AMODulation:TYPe	Sets the analog modulation type	7-11
SYSTem:INFormation:AMODulation:TYPe?	Queries the analog modulation type	7-11
SYSTem:STATus?	Queries the system status	7-11
SYSTem:FAULt?	Queries current system faults	7-12
SYSTem:INDicator:LASer	Turn ON/OFF laser head status indicator(s)	7-14
SYSTem:INDicator:LASer?	Queries laser head status indicator(s)	7-14
SYSTem:ERRor:COUNt?	Queries the number of error records in the error queue	7-14
SYSTem:ERRor:NEXT?	Queries the next error record(s) in the error queue	7-15
SYSTem:ERRor:CLEar	Clears all error records in the error queue	7-15
<b>OBIS Common Commands/Queries</b>		
<i>System Information</i>		
SYSTem:INFormation:MODEl?	Retrieves the model name of the laser	7-15
SYSTem:INFormation:MDATe?	Retrieves the manufacture date of the device	7-15
SYSTem:INFormation:CDATe?	Retrieves the calibration date of the device	7-16
SYSTem:INFormation:SNUMber?	Retrieves the serial number of the laser	7-16
SYSTem:INFormation:PNUMber?	Retrieves the manufacturer part number of the laser	7-16
SYSTem:INFormation:FVERsion?	Retrieves the current firmware version	7-16
SYSTem:INFormation:PVERsion?	Retrieves the current OBIS protocol version	7-16
SYSTem:INFormation:WAVelength?	Retrieves the wavelength of the laser	7-16
SYSTem:INFormation:POWer?	Retrieves the power rating of the laser head	7-17
SYSTem:INFormation:TYPe?	Retrieves the device type	7-17
SOURce:POWer:NOMinal?	Returns the nominal CW laser output power	7-17
SOURce:POWer:LIMit:LOW?	Returns the minimum CW laser output power	7-17
SOURce:POWer:LIMit:HIGH?	Returns the maximum CW laser output power	7-17
SYSTem:INFormation:USER	Enters and stores user-defined information	7-18
SYSTem:INFormation:USER?	Queries user-defined information	7-18
SYSTem:INFormation:FCDate	Enters and stores date of last field calibration	7-18
SYSTem:INFormation:FCDate ?	Queries date of last field calibration	7-18
<i>System State</i>		
SYSTem:CYCLes?	Returns the number of ON/OFF power cycles	7-18
SYSTem:HOURs?	Returns the hours the laser head has been powered on	7-18
SYSTem:DIODE:HOURs?	Returns the hours the laser diode has operated	7-18
SOURce:POWer:LEVel?	Returns the present output power of the laser head	7-19
SOURce:POWer:CURRent?	Returns the present output current of the laser head	7-19
SOURce:TEMPerature:BASEplate?	Returns the present laser head base plate temperature	7-19
SYSTem:LOCK?	Returns the status of the system interlock	7-19
<i>Operational</i>		

Table 7-1. Host Command Quick Reference (Sheet 3 of 3)

Command	Description	Page No.
SOURce:AM:INTernal	Sets the laser operating mode to internal CW	7-20
SOURce:AM:EXTernal	Sets the laser operating mode to external modulation	7-20
SOURce:AM:SOURce?	Queries the current operating mode of the laser	7-20
SOURce:POWer:LEVel:IMMEDIATE:AMPLitude	Sets present laser power level	7-20
SOURce:AM:STATe	Turns the laser ON or OFF	7-21
SOURce:AM:STATe?	Queries the current laser emission status	7-21
SYSTem:CDRH	Enables or disables the CDRH laser emission delay	7-21
SYSTem:CDRH?	Queries the status of the CDRH laser emission delay	7-21
<b>OBIS Optional Commands/Queries</b>		
SOURce:TEMPerature:APRobe	Enables/disables temperature control of the laser diode	7-21
SOURce:TEMPerature:APRobe?	Queries temperature control of the laser diode	7-21
<b>DDL-Specific Commands/Queries</b>		
SOURce:POWer:CALibration	Starts a self-laser power calibration	7-22
SOURce:POWer:UNCalibration	Undoes the filed calibration	7-22
SOURce:TEMPerature:PROTection:INTernal:HIGH?	Queries the high internal temperature limit settings	7-22
SOURce:TEMPerature:PROTection:INTernal:LOW?	Queries the low internal temperature limit settings	7-22
SOURce:TEMPerature:DIODE?	Queries the present laser head diode temperature	7-22
SOURce:TEMPerature:DSEtpoint?	Queries the diode set point temperature	7-23
SOURce:TEMPerature:INTernal?	Queries the present internal laser temperature	7-23

## Message Considerations

### Communication Port Selection

The laser head design includes both USB and CCB communication ports.

The communication protocol described within this section works identically on either port; however, the ports are mutually exclusive and cannot be used simultaneously.

When both USB and CCB connections are connected, the laser head gives the CCB port precedence and ignores any input received from the USB port. Note that certain information on the laser head/controller communications—such as one controller talking to multiple laser heads—is part of future expansion protocol and is not applicable to the OBIS Remote.

## **Message Completion Handshake**

SCPI message round trip handshaking is implemented on every message sent by the laser head firmware; however, the handshaking may be disabled using an SCPI command. Change of the setting will be saved in non-volatile memory.

This handshake serves several purposes:

1. It provides an indication to the host/controller that the message was received
2. It provides a synchronization mechanism to the host/controller so it will know when a message has been processed to completion so a new message may be sent
3. It provides the host/controller with an indication of any errors that may have occurred.

The handshake is a short message string that is sent as the last action performed when handling a received message. The handshake string represents either an OK response or an error response if a received message raises an error condition.

Note that quotation marks as depicted here are never included in the handshake string.

The OK response is formatted as "OK\r\n".

Error responses are formatted as "ERR<n>\r\n" where <n> represents the error code number. Negative numbers are permitted in the error string.

When handshaking is enabled, OBIS devices transmit one of the following handshake reply strings in response to each received command or query:

- Valid commands with valid data parameters will reply with "OK\r\n"
- Valid queries with any optional valid data reply as explicitly defined elsewhere in this section, followed by "OK\r\n". For example, if querying the model name string, the laser will transmit the model name string followed by the "OK\r\n" string.
- Valid commands or queries which result in an error reply with "ERR<n>\r\n"
- Unrecognized or unsupported commands or queries reply with "ERR-100\r\n"

Note that the message completion handshake is not transmitted in response to a command that has been broadcast to all devices.

## **Message Terminators**

Messages between the laser head and the host computer or controller are comprised entirely of ASCII string characters; no binary messages are supported. All message strings passing through the host interface are terminated to signal the end of a message string. The maximum message length supported is 255 bytes, which includes all terminating characters.

## **Messages Received by the Laser**

Messages received by the laser must be terminated by a carriage return (decimal 13). A line feed (decimal 10) following the carriage return is ignored so messages may be terminated with a carriage return and line feed pair. A command or query is considered incomplete without proper termination.

## **Messages Sent by the Laser**

All messages sent by the laser are terminated by a carriage return (decimal 13) and line feed (decimal 10) pair. The maximum length of any message sent by the laser is limited to 255 bytes, including all terminating characters.

## **Message Syntax**

Syntax specified by the SCPI and IEEE 488.2 Standards is followed unless otherwise specified. Refer to the SCPI and IEEE 488.2 Standards for more information.

Notably, the base-10 numeric data format specification is used heavily in this document and covered in the IEEE 488.2 Standard. Unless otherwise specified, numeric data items referred to as NRf (IEEE flexible numeric representation) are interchangeable and may be represented in any of these formats:

- integer values
- non-scientific notation floating point values
- scientific notation floating point values (uppercase or lowercase E)

For example, the following data values are functionally equivalent:

- 31256
- 31256.0
- 3.1256E4
- 31.256E3
- +3.1256E+4.

Unless otherwise specified, non-numeric data items (typically referred to as strings) are not quoted.

Devices interpret hexadecimal data using the following rules:

- Uppercase and lowercase are accepted (“FE” is the same as “fe”)
- Leading zeroes are required and accepted (“0A” is the same as “A”)
- The data string may optionally be preceded by a “0x” or “0X” C hexadecimal notation idiom (0xD2C4 is the same as D2C4)
- Following the optional “0x” prefix, the acceptable characters are from the list: 0, 1, 2, 3, 4, 5, 6, 7, 8, 9, a, b, c, d, e, f, A, B, C, D, E, and F

Enumerated values must match exactly, using the long form/short form comparison rules defined under the SCPI Standard.

Dates (manufacturing date, calibration date, etc.) will use the YYYYMMDD format. Using this format, dates may be stored as ASCII strings or as numeric long integers and converted easily from one format to the other.

## **Device Selection Syntax**

Many common commands are supported by all OBIS devices. When such a command is transmitted by a host computer to a system of devices (a controller and one or more laser heads), an ambiguity exists where the exact destination device is not clear.

The SCPI protocol provides a method to communicate with multiple virtual devices within an instrument. Since a complete OBIS system could be considered an “instrument” (controller) with multiple “virtual devices” (laser heads) this mechanism is used to disambiguate the destination of a command.

A SCPI command consists of one or more words separated by delimiters. The first word in a command string is called the base word.

SCPI channel selection is performed by appending a numeric suffix to the base word in any command string. When the numeric suffix is left off or has a value of zero, the command refers to the first connected device.

For example, “\*idn?\*” and “\*idn0?” query strings both refer to the first connected device. If a host computer is connected to a controller and this query is issued, it will be responded to by the controller. If the host is connected directly to a laser head, without going through a controller, the first connected device is the laser head and it should respond.

Consider the scenario where the host computer is connected to a mini controller, which, in turn, is connected to a laser head.

If the host issues the “\*idn?” query, the OBIS Remote should respond. If, however, the host appends a numeric suffix to the base word of the query, then the suffix specifies the device which should respond. In this scenario “\*idn?” and “\*idn0?” would be responded to by the OBIS Remote, “\*idn1?” would be responded to by the laser head, and “\*idn2?” would receive no response since device number 2 does not exist.

If the host is connected to a master controller with four connected laser heads, then a missing or zero suffix would apply to the master controller and suffixes 1..4 would refer to laser heads 1..4.

The numeric suffix mechanism may be applied to the base word of any command or query.

As an implementation detail, laser heads should always respond to commands with either no suffix or suffixes of 0 or 255 to accommodate connections to a bus and also directly to a host computer.

When host commands are routed through an OBIS controller, the numeric suffix will be stripped off before the command is transmitted to a laser head. In this instance, the laser head won't have to deal with the numeric suffix at all and can behave as if it were connected directly to a host.

However, when a laser head is connected directly to a host, then it is valid for the host to append a 0 to the command base word to refer to the first connected device. Since that device could be a laser head, the laser will support a numeric suffix of 0.

The numeric suffix of 255 refers to a command (not query) that is broadcast to all devices on the bus. Queries cannot be broadcast since a stream of query results won't make any sense to the host. Therefore, the command “SYSTem255:PROMpt ON” enables the system prompt for all devices while “SYSTem0:PROMpt ON” enables the prompt for the first connected device.

## **Command Prompt**

Each device implements the ability to output a command prompt to support interactive operation by an operator typing commands in a terminal program. A command has been specified to describe the command prompt behavior.

Note that the command prompt will not be transmitted in response to a command that has been broadcast to all devices.

## Broadcast Commands

It is possible that a host message could be broadcast to all attached devices. Generally the broadcast capability is best used when a command is needed to synchronize the action of a group of devices (such as turning all connected lasers on or off simultaneously). The ability to broadcast device queries is prohibited.

Laser heads silently ignore any query that is broadcast and will act upon a broadcast command, if possible, without transmitting anything in response (including error, handshake, or command prompt strings).

Controllers respond to queries that are broadcast by returning error 103 along with optional handshake and command prompt strings.

Controllers respond to commands that are broadcast by rebroadcasting them to all devices on the bus, performing the broadcast action locally if appropriate for the command, and then returning any optional handshake and command prompt strings to the host.

This method allows the host to receive a single handshake and/or command prompt when a command is broadcast to several devices.

## Commands and Queries

The OBIS Laser Head Protocol supports three types of laser devices:

- OBIS LX - Direct Diode Lasers (DDL)
- OBIS LS - Optically Pumped Semiconductor Lasers (OPSL)
- Other similar accessories

Each of these laser types support the common command sets and zero or more of the extension command sets, as shown in the following table.

**Table 7-2. Supported Commands by Laser Type**

Command Set	OBIS LX (DDL)	OBIS LS (OPSL)	Other
SCPI Common Command Set	X	X	X
OBIS Common Command Set	X	X	X
OBIS LX Extension Command Set	X		
OBIS LS Extension Command Set		X	



## Mandatory Commands and Queries

### IEEE-488.2 Mandated Commands/Queries

The SCPI Standard specifies a mandatory set of IEEE-488.2 common commands. All of these commands and queries start with an asterisk. Refer to the IEEE-488.2 specification for more detailed information concerning these commands.

#### Identification Query - \*IDN?

Gets the laser head's identification string, such as model name, firm-ware version, and firmware date.

Query: \*IDN?

Reply: "Coherent, Inc" + "-" + <model name> + "-" + <firmware version> + "-" + <firmware date>

The dash sign separates all fields within the reply string. The first field will always be "Coherent, Inc". The second field is the model name, which varies based on the laser head. The third field is the firmware version number, having the format "V<major>.<minor><optional qualifier characters>". The fourth field is the firmware date, having the form YYYYMMDD. The reply string will not be quoted.

For example, a typical identification string might look like:

"Coherent, Inc - OBIS 405nm 50mW C - V1.3 - 20090630" *Note: the quotes are not transmitted.*

#### Reset Command - \*RST

Causes a device to warm boot if implemented. Note that the message handshake is transmitted immediately prior to execution of the reset. If the command is not implemented, then no error is returned and no response is necessary.

Command: \*RST

Query: None

#### Self-test Query - \*TST?

Runs a laser self-test procedure, if implemented. Any detected faults are set in the laser fault code.

Query: \*TST?

Reply: <System Fault Code>

The returned system fault code is formatted as a 32-bit hex value. A value of 0 indicates no fault conditions. If the self-test is not implemented, a value of 0xffffffff is returned.

## **OBIS Mandatory Commands/Queries**

The OBIS Mandatory Command set is implemented by all OBIS compatible devices.

## **Session Control Commands**

### **Handshaking**

Toggles the system handshaking on and off. Setting is saved in persistent memory. Factory default is ON.

Command: SYSTem:COMMunicate:HANDshaking {ON|OFF}

Query: SYSTem:COMMunicate:HANDshaking?

Reply: ON|OFF

When enabled, the device transmits, in response to each received command or query, one of the handshaking strings described under “Message Completion Handshake” (p. 7-4).

Note that the handshaking reply is not transmitted in response to a command that has been broadcast to all devices, except by a controller device.

### **Command Prompt**

Toggles the system command prompt on and off. Setting is saved in persistent memory. Factory default is OFF.

Command: SYSTem:COMMunicate:PROMpt {ON|OFF}

Query: SYSTem:COMMunicate:PROMpt?

Reply: ON|OFF

When enabled the device outputs a command prompt after each reply string. The command prompt is preceded by a carriage return and line feed, and consists of a '>' character and a space character.

Note that the command prompt is not transmitted in response to a command that has been broadcast to all devices, except by a controller device.

### **Laser Auto Start**

Enables or disables the laser auto start feature. Setting is saved in persistent memory. Factory default is OFF.

Command: SYSTem:AUTostart {ON|OFF}

Query: SYSTem:AUTostart?

Reply: ON|OFF

If auto start is enabled, the device, when powered up, will automatically start emission at a previously-set level.

The auto start setting is saved in the non-volatile memory of the laser head. If the laser head is connected to a OBIS Remote through a SDR cable, this setting is overridden by the hardware switch of the min-controller; however, the ON/OFF position of the switch will not overwrite the setting in the laser head memory.

### Analog Modulation Type

Sets the analog modulation type that provides unique electrical impedance on the analog interface of the OBIS Remote. Factory default is 50Ω.

Command: SYSTem:INFormation:AMODulation:TYPE {1 | 2}

Query: SYSTem:INFormation:AMODulation:TYPE?

Reply: 1 | 2

The input impedance is 50Ω and 2 kΩ for type 1 and 2, respectively.

### System Status Query

Gets the system status code. The status code is returned in a string expressed in uppercase hexadecimal integer form. The 32-bit word represents a bit-mapped status indicator.

The MSB of the code is used to indicate if the code represents the status of a controller or a laser head. If the MSB is set, the code represents controller status. This is important since the meaning of some bits is subtly different for a controller. Refer to Table 7-3, below, for differences.

The following table describes status code bit mapping. The “Controller” column specifies the meaning of each bit when the status word is read from the controller and the “Laser Head” column specifies the bit meaning when the status word is read from a laser. The status word MSB indicates whether a status word is from a laser head or from a controller.

**Table 7-3. Status Code Bit Definitions (Sheet 1 of 2)**

Bit	Mask	Bit Label	Controller	Laser Head
0	00000001	Laser Fault	Logical OR from all lasers	Laser head faults—that is, fault words shown in Table 7-4 (p. 7-13)
1	00000002	Laser Emission	Logical OR from all lasers	Laser emission status
2	00000004	Laser Ready	Logical OR from all lasers	Laser ready status
3	00000008	Laser Standby	Logical OR from all lasers	Laser standby status
4	00000010	CDRH Delay	Logical OR from all lasers	Laser CDRH delay status

**Table 7-3. Status Code Bit Definitions (Sheet 2 of 2)**

Bit	Mask	Bit Label	Controller	Laser Head
5	00000020	Laser Hardware Fault	Logical OR from all lasers	Hardware related faults in Table 7-4 (p. 7-13)
6	00000040	Laser Error	Logical OR from all lasers	Laser error is queued
7	00000080	Laser Power Calibration	Logical OR from all lasers	Laser power is within factory calibration specification
8	00000100	Laser Warm Up	Logical OR from all lasers	Laser warm-up status
9	00000200	Laser Head Noise	Logical OR from all lasers	Noise level is over 30
10	00000400	External Operating Mode	Logical OR from all lasers	External operating mode is selected
11	00000800	Field Calibration	Logical OR from all lasers	Field calibration is in progress when set
12	00001000	Laser Power Voltage	Logical OR from all lasers	12V laser power voltage is present when set
...	...	...		
25	02000000	Controller Standby	Key switch is in "STANDBY" position	Always 0
26	04000000	Controller Interlock	"INTERLOCK" is open.	Always 0
27	08000000	Controller Enumeration	One or more laser heads have been enumerated	Always 0
28	10000000	Controller Error	Controller error flag	Always 0
29	20000000	Controller Fault	Controller fault status	Always 0
30	40000000	Remote Active	Host is connected	Always 0
31	80000000	Controller Indicator	Status word is from controller.	Always 0

Unspecified bits are reserved and are zero.

Command: None

Query: SYSTem:STATus?

Reply: <status word>

As an example, if the laser is turned on, but is being delayed by the CDRH required delay, the system status query returns:

00000012      (*Laser emission enabled but delayed by CDRH*)

**System Fault Query**

Gets the system fault code. The fault code is returned in a string expressed in uppercase hexadecimal integer form. The 32-bit word represents a bit-mapped fault indicator.

The MSB of the code is used to indicate if the code represents the status of a controller or a laser head. If the MSB is set, the code represents controller fault status. This is important since the meaning of some bits is subtly different for a controller. Refer to the following table for differences.

The following table describes fault code bit mapping.

**Table 7-4. Fault Code Bit Definitions**

Bit <sup>a</sup>	Mask	Bit Label	Controller	Laser Head
0	00000001	Base Plate Temp. Fault	Logical OR from all lasers	Base plate temperature out of range
1	00000002	Diode Temp. Fault	Logical OR from all lasers	Diode temperature out of range
2	00000004	Internal Temp. Fault	Logical OR from all lasers	Internal temperature out of range
3	00000008	Laser Power Supply Fault	Logical OR from all lasers	No electrical power to laser diode
4	00000010	I2C Error	Logical OR from all lasers	I2C bus error
5	00000020	Over Current	Logical OR from all lasers	Diode over current
6	00000040	Laser Checksum Error	Logical OR from all lasers	EEPROM checksum error in at least one section
7	00000080	Checksum Recovery	Logical OR from all lasers	EEPROM was restored to default settings
8	00000100	Buffer Overflow	Logical OR from all lasers	Bus message buffer overflow
9	00000200	Warm-up limit fault	Logical OR from all lasers	Warm-up time limit exceeded
10	00000400	TEC Driver Error	Logical OR from all lasers	TE controller driver failure
11	00000800	CCB Error	Logical OR from all lasers	RS-485 bus error
12	00001000	Diode Temp Limit Error	Logical OR from all lasers	Diode temperature off by > 3°C from set point
13	00002000	Laser Ready Fault	Logical OR from all lasers	Fail to emit at set power level
14	00004000	Photodiode Fault	Logical OR from all lasers	Negative photodiode readout
15	00008000	Fatal Fault	Logical OR from all lasers	Irrecoverable system failure
16	00010000	Startup Fault	Logical OR from all lasers	Errors encountered during firmware startup
17	00020000	Watchdog Timer Reset	Logical OR from all lasers	Firmware resumed from watchdog reset
18	00040000	Field Calibration	Logical OR from all lasers	Errors encountered during field calibration
...	...	...		
30	40000000	Controller Checksum	Controller checksum error	Always 0
31	80000000	Controller Status	Fault word is from controller	Always 0

a. Unspecified bits are reserved and will be zero.

Command: None

Query: SYSTem:FAULt?

Reply: <fault word>

As an example, if the base plate and laser diode temperature limits are both exceeded, the system fault query will return:

00000003      (*Base Plate & Laser Diode Temp. Limits Exceeded*)

### **Turn On/Off Laser Status Indicator**

Turns on (or turns off) the status indicator(s) associated with the laser head. Setting is saved in persistent memory. Factory default is ON.

Command: SYSTem:INDicator:LASer {ON|OFF}

Query: SYSTem:INDicator:LASer?

Reply: ON|OFF

This command is used to turn on (or turn off) the LED status indicator(s) that is visible to the user. The status bits returned by "SYSTem:STATus?", however, are not affected by this command.

### **Error Record Reporting**

Programming and system errors will occasionally occur while testing or debugging remote programs and during measurement. Error strings follow the SCPI Standard for error record definition:

<error code>,<quoted error string><CR><LF>

The host queries for errors in two steps.

1. First, the host queries for the number of error records available (N).
2. Secondly, the host queries N times for the error records.

Errors are stacked up to 20 deep. In the case of error overflow, the last error in the error list is an indication of error overflow.

Note that the error records defined in this section are the errors generated in response to external commands or queries. Any errors generated from the internal operation of the laser head or controller will be reflected in the fault code displayed in Table 7-4 (p. 7-13).

### Error Count Query

Gets the number of error records in the error queue at the time of the query.

Command: none

Query: SYSTem:ERRor:COUNt?

Reply: <integer count of error records stored>

### Error Query

Gets the next error record(s) in the error queue. More than one error record may be queried using the optional <error record count> parameter, which must be an integer value. A single error record is returned if <error record count> is not specified. No reply is transmitted if there are no available error records.

As the device transmits each error record:

- The error record is permanently removed from the error queue
- The queued error record count is decremented by one

Command: none

Query: SYSTem:ERRor:NEXT?

Reply: <next available error record>

### All Error Clear

Clears all error records in the error queue.

Command: SYSTem:ERRor:CLEar

Query: none

## **OBIS Common Commands and Queries**

OBIS Common Commands and Queries is implemented by all OBIS devices that support the features contained in this section. If a device does not support a given feature, the command may be ignored.

## **System Information Queries**

The System Information commands allow a host to retrieve static information describing the characteristics of the laser.

### **System Model Name Query**

Retrieves the model name of the laser.

Query: SYSTem:INFormation:MODEl?

Reply: <model name>

### **System Manufacture Date Query**

Retrieves the manufacture date of the device.

Command: SYSTem:INFormation:MDATe?

Reply: <manufacture date>

### **System Calibration Date Query**

Retrieves the calibration date of the device.

Command: SYSTem:INFormation:CDATe?

Reply: <calibration date>

### **System Serial Number Query**

Retrieves the serial number of the laser.

Query: SYSTem:INFormation:SNUMber?

Reply: <serial number>

### **System Part Number Query**

Retrieves the manufacturer part number of the laser.

Query: SYSTem:INFormation:PNUMber?

Reply: <manufacturer part number>

### **System Firmware Version Query**

Retrieves the current firmware version from the laser firmware. The format of the returned firmware version number string is identical to that described in the \*IDN? Query.

Query: SYSTem:INFormation:FVERsion?

Reply: <current firmware version>

### **System Protocol Version Query**

Retrieves the current OBIS protocol version from the laser firmware. The format of the returned firmware version number string is: "P<major>.<minor><optional qualifier characters>".

Query: SYSTem:INFormation:PVERsion?

Reply: <current protocol version>

The firmware version is the format: "P<major>.<minor><optional qualifier characters>". For example, P1.0a is a valid firmware version format.

### **System Wavelength Query**

Retrieves the actual wavelength (in nanometers) of the laser.

Query: SYSTem:INFormation:WAVelength?

Reply: <wavelength>



### **System Power Rating Query**

Retrieves the power rating (in watts) of the laser head.

Query: SYSTem:INFormation:POWer?

Reply: <power>

The power rating is minimum output power under a given set of operating conditions during the laser life. It is generally the same as nominal power

### **Device Type Query**

Retrieves the device type. The device includes laser head and controller. At this time, the types of lasers supported by this protocol are OBIS LX (Direct Diode Lasers (DDL)), OBIS LS (Optically Pumped Semiconductor Lasers (OPSL)) and OTHER. The set of extended laser-specific commands is determined by the response to this query. The type of the controller is hard coded in the controller.

Query: SYSTem:INFormation:TYPe?

Reply: DDL|OPSL|MINI|MASTER|OTHER

### **CW Nominal Power Query**

Returns the nominal CW laser output power in watts.

Query: SOURce:POWer:NOMinal?

Reply: <x.xxxxx>

The reply string represents the nominal power value in watts.

### **CW Minimum Power Query**

Returns the minimum CW laser output power in watts.

Query: SOURce:POWer:LIMit:LOW?

Reply: <x.xxxxx>

The reply string represents the minimum power in watts.

### **CW Maximum Power Query**

Returns the maximum CW laser output power in watts.

Query: SOURce:POWer:LIMit:HIGH?

Reply: <x.xxxxx>

The reply string represents the maximum power value in watts.

### **Set/Query User-Defined ID**

Enters and stores user-defined identification or any other information the user desires to store. The information entered is stored in nonvolatile memory. The user can enter up to four items, with each comprised of up to 31 characters.

Command: SYSTem:INFormation:USER <item number> , <item>

Query: SYSTem:INFormation:USER? <item number>

Reply: Item stored at the location pointed to by <item number>

Note: The item number starts at zero.

### **Set/Query Field Calibration Date**

Enters and stores the date on which the last field calibration was performed. This is normally done by the user or Coherent field service personnel.

Command: SYSTem:INFormation:FCDate <alphanumeric string>

Query: SYSTem:INFormation:FCDate?

Reply: <alphanumeric string >

Note: The number of alphanumeric character is limited to 31 maximum.

## **System State Commands/Queries**

System State commands allow a host to retrieve dynamic information describing the current operational state of the laser.

### **System Power Cycle Query**

Returns the number of ON/OFF power cycles the laser has endured.

Query: SYSTem:CYCLes?

Reply: <integer cycle count>

### **System Power Hour Query**

Returns the number of hours the laser head has been powered on.

Query: SYSTem:HOURs?

Reply: <value in x.xx format>

### **Diode Hour Query**

Returns the number of hours the laser diode has operated. This is defined as the accumulation of time while the "Laser Enable" pin is asserted.

Query: SYSTem:DIODE:HOURs?

Reply: <value in x.xx format>

### **System Output Power Level Query**

Returns the present output power of the laser head measured in watts.

Query: SOURce:POWer:LEVel?

Reply: <x.xxxxx>

The reply string is an NRf value representing the present laser output power measured in watts.

### **System Output Current Query**

Returns the present output current of the laser head measured in amps.

Query: SOURce:POWer:CURRent?

Reply: <x.xxxxx>

The reply string is an NRf value representing the present laser output current measured in amps.

### **Base Plate Temperature Query**

Returns the present laser head base plate temperature. An optional unit indicator may be specified. If the 'C' unit indicator is specified, or if the unit indicator is left off, the returned value represents the laser base plate temperature in degrees C. If the 'F' unit indicator is specified, the returned value represents the laser base temperature in degrees F.

Query: SOURce:TEMPerature:BASEplate? {C|F}

Reply: <x.xU where U is the unit indicator 'C' or 'F'>

The reply string represents the base temperature in NRf format, with a unit indicator of 'C' or 'F' appended.

### **System Interlock Query**

Returns the status of the system interlock. The method of determining interlock status is device dependent. This feature may not apply to the laser head itself.

Query: SYSTem:LOCK?

Reply: ON|OFF

Query returns the interlock state in string format.

## **Operational Commands/Queries**

Operational commands and queries are used to configure and operate the laser from a Host or Controller. These commands and queries are for use by user level applications as well.

## Laser Operating Mode Selection

Five mutually exclusive operating modes are available:

- CWP (continuous wave, constant power)
- CWC (continuous wave, constant current)
- DIGITAL (CW with external digital modulation)
- ANALOG (CW with external analog modulation)
- MIXED (CW with external digital + analog modulation)

The exact meaning of the selected mode is device-dependent.

### Select CW Mode

Sets the laser operating mode to internal CW and deselects external modulation. The setting is saved in non-volatile memory.

The default setting is CW with constant power or CWP.

Command: SOURce:AM:INTernal CWP|CWC

### Select Modulation Mode

Sets the laser operating mode to CW constant current modulated by one or more external sources. MIXED source combines both external digital and external analog modulation. The setting is saved in non-volatile memory.

Command: SOURce:AM:EXTernal DIGital|ANALog|MIXed

## Laser Operating Mode Query

Queries the current operating mode of the laser.

Query: SOURce:AM:SOURce?

Reply: CWP|CWC|DIGITAL|ANALOG|MIXED

The reply string represents the present laser operating mode, where CWP and CWC are not modulated externally and the other modes imply external modulation.

## Set/Query Laser Power Level

Sets present laser power level in watts. Setting power level does not turn the laser on.

Command: SOURce:POWer:LEVel:IMMEDIATE:AMPLitude <value>

Query: SOURce:POWer:LEVel:IMMEDIATE:AMPLitude?

Reply: <x.xxxxx>

The reply string represents the present laser power level setting as an NRf value in watts.

### Set/Query Laser Enable

Turns the laser ON or OFF. When turning the laser ON, actual laser emission may be delayed due to internal circuit stabilization logic and/or CDRH delays.

Command: SOURce:AM:STATe ON|OFF

Query: SOURce:AM:STATe?

Reply: ON|OFF

Query returns the present laser ON/OFF state in string format.

### Set/Query CDRH Delay



---

#### ***NOTICE!***

**Disabling the CDRH delay will render the OBIS system non-CDRH compliant.**

---

Enables or disables the CDRH five-second laser emission delay.

Command: SYSTem:CDRH ON|OFF

Query: SYSTem:CDRH?

Reply: ON|OFF

Query returns the present CDRH setting in string format.

## OBIS Optional Commands

### Set/Query TEC Enable

Enables or disables temperature control of the laser diode via the TEC circuit.

Command: SOURce:TEMPerature:APRobe ON|OFF

Query: SOURce:TEMPerature:APRobe?

Reply: ON|OFF

Query returns the present ON/OFF TEC control state in string format.

## DDL-Specific Commands

The commands in this section pertain to DDL lasers only.

### **Enable/Undo Laser Power Field Calibration**

Starts a self laser power calibration using an internal reference. It is used to re-calibrate the laser power in the field against possible degradation of both laser diode and internal reference during its lifetime. You may undo the field calibration if need be.

Command: SOURce:POWer:CALibration

Command: SOURce:POWer:UNCalibration

The calibration process involved in this command may take a few minutes to finish. Do not disrupt the power supply until the process is complete. Status bit 11 is set up as a handshaking mechanism for the host program for the progress of calibration process.

### **Internal Temperature Limit Queries**

These queries return the present internal temperature limit settings. An optional unit indicator may be specified. If the 'C' unit indicator is specified, or if the unit indicator is left off, the returned value represents the internal temperature high or low limit in degrees C. If the 'F' unit indicator is specified, the returned value represents the internal temperature limit in degrees F. The internal temperature represents the temperature taken from a built-in temperature sensor of the microprocessor.

The reply string represents the limit value in NRf format with a unit indicator of 'C' or 'F' appended.

#### **Internal Temperature High Limit Query**

Query: SOURce:TEMPerature:PROTection:INTernal:HIGH?

Reply: <x.xU where U is the unit indicator 'C' or 'F'>

#### **Internal Temperature Low Limit Query**

Query: SOURce:TEMPerature:PROTection:INTernal:LOW?

Reply: <x.xU where U is the unit indicator 'C' or 'F'>

### **Diode Temperature Query**

Returns the present laser head diode temperature. An optional unit indicator may be specified. If the 'C' unit indicator is specified, or if the unit indicator is left off, the returned value represents the laser diode temperature in degrees C. If the 'F' unit indicator is specified, the returned value represents the laser diode temperature in degrees F.

Query: SOURce:TEMPerature:DIODE? {C|F}

Reply: <x.xU where U is the unit indicator 'C' or 'F'>

The reply string represents the diode temperature in NRf format with a unit indicator of 'C' or 'F' appended.

### Diode Set Point Temperature Query

Returns the diode set point temperature that the TEC controller manages to maintain. An optional unit indicator may be specified. If the 'C' unit indicator is specified, or if the unit indicator is left off, the returned value represents the laser diode temperature in degrees C. If the 'F' unit indicator is specified the returned value represents the laser diode temperature in degrees F.

Query: SOURce:TEMPerature:DSETpoint? {C|F}

Reply: <x.xU where U is the unit indicator 'C' or 'F'>

The reply string represents the target temperature in NRf format with a unit indicator of 'C' or 'F' appended.

### Internal Temperature Query

Returns the present internal laser temperature. An optional unit indicator may be specified. If the 'C' unit indicator is specified, or if the unit indicator is left off, the returned value represents the internal laser temperature in degrees C. If the 'F' unit indicator is specified the returned value represents the laser base temperature in degrees F.

Query: SOURce:TEMPerature:INTernal? {C|F}

Reply: <x.xU where U is the unit indicator 'C' or 'F'>

The reply string represents the internal laser temperature in NRf format with a unit indicator of 'C' or 'F' appended.

**Table 7-5. Fault Codes—OBIS Remote (Mini) and Laser Head (LH) (Sheet 1 of 4)**

**Note: A warm or cold device reboot is required to clear an OBIS Remote or laser head fault.**

Code Bit	Error Value	Mini	LH	Error Description	Cause and Possible Solution
0	00000001		X	Baseplate temperature fault	<b>Cause:</b> Baseplate temperatures is greater than 40°C or lower than 10°C. <b>Solution:</b> Improve heat sink to reduce baseplate temperature or adjust the ambient temperature where the laser operates.
1	00000002		X	Diode temperature fault	<b>Cause:</b> Diode temperature is greater than 40°C or lower than 10°C. <b>Solution:</b> Make sure the TE cooler is on and/or adjust the ambient temperature where the laser operates.
2	00000004		X	Internal temperature fault	<b>Cause:</b> Microprocessor temperature exceeds factory set limit. <b>Solution:</b> Make sure the TE cooler is on and the ambient temperature is within the specified range.

**Table 7-5. Fault Codes—OBIS Remote (Mini) and Laser Head (LH) (Sheet 2 of 4)**

**Note: A warm or cold device reboot is required to clear an OBIS Remote or laser head fault.**

Code Bit	Error Value	Mini	LH	Error Description	Cause and Possible Solution
3	00000008		X	Laser power supply fault	<b>Cause:</b> There is no electrical power to the laser diode. <b>Solution:</b> Make sure the SDR cable is plugged in and secured properly on both ends.
4	00000010		X	Device internal I2C bus error	<b>Cause:</b> An error was encountered in internal I2C bus communications. <b>Solution:</b> Perform a warm or cold reboot of the laser system. If the problem persists, contact Coherent technical support.
5	00000020		X	Laser diode over-current error	<b>Cause:</b> Laser diode current exceeds the specified upper limit. <b>Solution:</b> Turn off laser emission and reboot the device. If the problem persists, contact Coherent technical support.
6	00000040		X	Laser checksum error	<b>Cause:</b> An error occurred that is associated with persistent memory where critical data is stored. <b>Solution:</b> Reboot the laser system. If the problem persists, contact Coherent technical support.
7	00000080		X	Checksum recovery error	<b>Cause:</b> An error occurred when trying to recover from checksum error via host command. <b>Solution:</b> Contact Coherent technical support.
8	00000100		X	Message buffer overflow	<b>Cause:</b> An overflow error associated with message buffer was encountered in the firmware. <b>Solution:</b> Perform a warm or cold reboot of the laser system. If the problem persists, contact Coherent technical support.
9	00000200		X	Warm-up limit fault	<b>Cause:</b> The 5-minute warm-up limit was exceeded. <b>Solution:</b> Make sure the TE cooler is enabled. If the laser was started in a very low temperature environment, keep the laser powered for 10-15 minutes, then reboot the device.
10	00000400		X	TEC control error	<b>Cause:</b> An error associated with the TEC operation was encountered. It can be caused by insufficient heat sink. <b>Solution:</b> Make sure heat sink is sufficient, then perform a device reboot. If the problem persists, contact Coherent technical support.



Table 7-5. Fault Codes—OBIS Remote (Mini) and Laser Head (LH) (Sheet 3 of 4)

**Note: A warm or cold device reboot is required to clear an OBIS Remote or laser head fault.**

Code Bit	Error Value	Mini	LH	Error Description	Cause and Possible Solution
11	00000800		X	Coherent connection bus error	<b>Cause:</b> An error associated with RS485 bus communications between the laser and OBIS Remote was encountered. <b>Solution:</b> Make sure the SDR cable is plugged in and secured properly on both ends.
12	00001000		X	Diode temperature limit error	<b>Cause:</b> Laser diode temperature deviates from the temperature set point by more than 3°C. <b>Solution:</b> Make sure the TE cooler is turned on. If the laser warm-up process is disabled, keep the laser running for 10-15 minutes, then perform a device reboot.
13	00002000		X	Laser ready fault	<b>Cause:</b> Laser fails to emit within $\pm 2\%$ of the requested power. <b>Solution:</b> If the problem persists, contact Coherent technical support for a system recalibration.
14	00004000		X	Photodiode fault	<b>Cause:</b> Readings from the internal photodiode for power control were negative. <b>Solution:</b> Reboot the laser head. If the problem persists, Contact Coherent technical support.
15	00008000		X	Device fatal error	<b>Cause:</b> An irrecoverable system failure was encountered. <b>Solution:</b> Contact Coherent technical support.
16	00010000		X	Startup error	<b>Cause:</b> Errors were encountered during firmware startup. <b>Solution:</b> Perform a cold or warm device reboot.
17	00020000		X	Watchdog timer reset	<b>Cause:</b> Firmware was resumed from a processor watchdog reset. <b>Solution:</b> Contact Coherent technical support.
18	00040000		X	Field calibration error	<b>Cause:</b> Errors were encountered while running power field calibration. <b>Solution:</b> Re-run field calibration. If the problem persists, contact Coherent technical support.
...	...	...	...	...	

**Table 7-5. Fault Codes—OBIS Remote (Mini) and Laser Head (LH) (Sheet 4 of 4)**

**Note: A warm or cold device reboot is required to clear an OBIS Remote or laser head fault.**

Code Bit	Error Value	Mini	LH	Error Description	Cause and Possible Solution
30	40000000	X		Min-controller checksum error	<b>Cause:</b> An error associated with persistent memory was encountered. <b>Solution:</b> Reboot the OBIS Remote. If the problem persists, contact Coherent technical support.
31	80000000	X		Fault status from OBIS Remote	<b>Cause:</b> A firmware or hardware fault was encountered in the OBIS Remote. <b>Solution:</b> Reboot the OBIS Remote. If the problem persists, contact Coherent technical support.

## Controls and Queries

The OBIS control and query command set conforms to the Standard Commands for Programmable Instruments (SCPI) and IEEE 488.2 standards. In short, a SCPI control command consists of a header built with keyword(s) plus one or more optional parameters. The header and the parameter(s) are separated by a space. A query command is formed by directly appending a question mark to the end of the header. For more detailed information on SCPI commands and syntax, refer to the SCPI standard documentation.

Here's a brief description of the notation conventions for the OBIS commands:

- Parameter(s) following a control command is required.
- Item(s) within the angle brackets following a control or query command is required.
- Item(s) within the curly brackets following a control or query command is optional.
- Acceptable parameters or items required for a control or query command are separated by the OR symbol “|”.
- The upper and lower bounds of the range for a parameter or item are given in parentheses.

Table 7-6 and Table 7-7 contain a complete list of OBIS SCPI control and query commands for the OBIS Remote (MINI), the OBIS LX direct diode laser (DDL), and the OBIS LS optically-pumped semiconductor laser (OPSL).

Table 7-6. OBIS Control Commands (Sheet 1 of 2)

Command	Remote	OBIS LX (DDL)	OBIS LS (OPSL)	Description
*RST	X	X	X	Performs a firmware warm reset. Message handshaking, if enabled, is transmitted prior to the execution of reset. This command may be used to clear a fault condition.
SYSTem:COMMuni- cate:HANDshaking ON OFF	X	X	X	Enables   Disables host/controller communication handshaking. This setting is stored in persistent memory so that it remains unchanged after a power ON/OFF cycle.
SYSTem:COMMuni- cate:PROMpt ON OFF	X	X	X	Enables   Disables command/query prompt (>). This setting is stored in persistent memory.
SYSTem:AUTostart ON OFF		X	X	Enables   Disables laser power automatic emission. Note: This setting will be overridden by interlock switch, key switch, or other hardware mechanisms in the OBIS Remote. This setting is stored in persistent memory.
SYSTem:CDRH ON OFF		X	X	Enables   Disables CDRH delay. This setting is stored in persistent memory.
SYSTem:DIODE:WARMup ON OFF		X	X	Enables   Disables laser diode warm-up process. If this process is disabled, the laser is capable of starting emission as soon as the electronics is up and running. If this process is enabled, the laser will not emit until after the warm-up process is complete, even if the laser-on command is issued or the auto start is enabled. This setting is stored in persistent memory.
SYSTem:RECOvery		X	X	Recovers device from checksum failure. This command may also be used to restore device to factory default settings. The laser head status LED illumination, if enabled, will be steady green while the device is recovering.
SYSTem:INForma- tion:AMODulation:TYPE 1 2	X			Selects electrical input impedance for the analog modulation channel of the OBIS Remote. Parameter 1 selects 50Ω while parameter 2 selects 2 kΩ. This setting is stored in persistent memory.
SYSTem:INDicator:LASer ON OFF		X	X	Enables   Disables illumination of LED status indicator. This setting does not affect the state of device status bits or fault bits. This setting is stored in persistent memory.
SYSTem:ERRor:CLEar	X	X	X	Clears host/controller communication error records.
SYSTem:INForma:USER <index>, <item>	X	X	X	Enters and stores user-defined identification or other information. <index> = (0, 3). <item> = (0, 31 characters).

**Table 7-6. OBIS Control Commands (Sheet 2 of 2)**

Command	Remote	OBIS LX (DDL)	OBIS LS (OPSL)	Description
SOURce:AM:INTernal CWP CWC		X	X	Sets laser internal operating mode. Note: The laser internal and external operating modes are mutually exclusive. CWC = CW constant power; CWC = CW constant current.
SOURce:AM:EXTernal DIGital ANALog MIXed		X	X	Sets laser external operating mode. Note: The laser internal and external operating modes are mutually exclusive and the laser head is required to connect to a OBIS Remote to use these modes. DIGital = digital modulation; ANALog = analog modulation; MIXed = digital + analog modulation.
SOURce:POWer:LEVel:IMM ediate:AMPLitude <laser_power>		X	X	Sets laser output power level in watts. <laser_power> = (0, 110% nominal power). This command itself will not enable laser emission. If laser emission has been enabled, this command will change the laser output power and the new setting is saved in persistent memory. Note: Setting power level to zero watts does not turn off the electrical power to the laser diode.
SOURce:AM:STATe ON OFF		X	X	Turns On   Turns Off laser emission. Actual laser emission may be delayed due to internal electronic circuit stabilization and/or CDRH delay.
SOURce:TEMPera- ture:APRobe ON OFF		X		Enables   Disables thermoelectric cooler for DDL laser head.
SOURce:POWer:CALibration		X		Performs field calibration for analog modulation. This command will result in a match of 5V analog input to 100% nominal power.

**Table 7-7. OBIS Query Commands (Sheet 1 of 3)**

Command	Mini	DDL	OPSL	Description
*IDN?	X	X	X	Returns device identification string that includes information about manufacturer name, product name, nominal wavelength, power rating, firm-ware version, and firmware release date in the format shown in this example: "Coherent, Inc - OBIS 405nm 50mW C - V1.0.1 - Dec 14 2010".
*TST?	X	X	X	Returns 0xFFFFFFFF for DDL.
SYSTem:COMMunicate:HAND- shaking?	X	X	X	Returns communication handshake setting. Replay = ON OFF.
SYSTem:COMMunicate:PROMpt?	X	X	X	Returns command prompt setting. Replay = ON OFF.
SYSTem:AUTostart?		X	X	Returns laser auto emission setting. Replay = ON OFF.
SYSTem:CDRH?		X	X	Returns CDRH delay setting. Replay = ON OFF.

Table 7-7. OBIS Query Commands (Sheet 2 of 3)

Command	Mini	DDL	OPSL	Description
SYSTem:FAULt?	X	X	X	Returns device fault bits in 32-bit hexadecimal format. Refer to Table 7-4 (p. 7-13) for definitions of device fault bits.
SYSTem:CYCLes?		X	X	Returns number of device power-on cycles.
SYSTem:DIODE:HOuR?		X		Returns accumulated laser emission hours. The returned value has a resolution of two digits after decimal point.
SYSTem:DIODE:WARMup?		X		Returns diode warm-up setting. Replay = ON OFF.
SYSTem:HOuR?		X	X	Returns accumulated device operating hours. The returned value has a resolution of two digits after decimal point.
SYSTem:LOCK?	X			Returns OBIS Remote interlock status. Replay = ON OFF, with ON = Close and OFF = Open.
SYSTem:INformation:AMODulation:TYPe?	X			Returns input impedance type for OBIS Remote analog modulation channel. Replay = 1 2, with 1 = 50 $\Omega$ and 2 = 2k $\Omega$ .
SYSTem:NOISe?		X		Returns noise level of laser power. The returned integer is a relative measure of laser power stability. It applies to constant power mode only. A level above 30 is considered noisy. It is normal to see a relatively high noise level when the laser is warming up or when the laser power is changed.
SYSTem:INDicator:LASer?		X	X	Returns LED status indicator setting. Replay = ON OFF.
SYSTem:ERRor:COUNt?	X	X	X	Returns host/controller communication error count.
SYSTem:ERRor:NEXt?	X	X	X	Returns host/controller communication error record.
SYSTem:INformation:MODEl?	X	X	X	Returns device modal.
SYSTem:INformation:MDATE?	X	X	X	Returns device manufacture date.
SYSTem:INformation:CDATE?	X	X	X	Returns device calibration date.
SYSTem:INformation:SNUMber?	X	X	X	Returns device serial number.
SYSTem:INformation:PNUMber?	X	X	X	Returns device manufacturer part number.
SYSTem:INformation:FVERsion?	X	X	X	Returns device firmware version.
SYSTem:INformation:WAVElength?		X	X	Returns laser nominal wavelength in nanometers based on a diode operating temperature of 25 degrees Celsius.
SYSTem:INformation:POWEr?		X	X	Returns laser power rating in watts.
SYSTem:INformation:TYPe?	X	X	X	Returns device type. Replay = MINI DDL OPSL.
SOURce:POWEr:LIMit:LOW?		X	X	Returns minimum laser power output in watts available in CW constant current or CW constant power mode.

**Table 7-7. OBIS Query Commands (Sheet 3 of 3)**

<b>Command</b>	<b>Mini</b>	<b>DDL</b>	<b>OPSL</b>	<b>Description</b>
SOURce:POWer:LIMit:HIGH?		X	X	Returns maximum laser power output in watts available in CW constant current or CW constant power mode.
SYSTem:INFormation:USER? <index>	X	X	X	Returns user defined identification. <index> = (0,3).
SOURce:POWer:LEVel?		X	X	Returns present laser output power in watts.
SOURce:POWer:CURRent?		X	X	Returns present laser output current in amperes.
SOURce:TEMPerature:BASEplate? {C F}		X	X	Returns present baseplate temperature.
SOURce:AM:SOURce?		X	X	Returns present laser operating mode. Replay = CWP CWC  DIG ANAL MIX.
SOURce:POWer:LEVel:IMMe-diate:AMPLitude?		X	X	Returns laser output power set level in watts.
SOURce:AM:STATE?		X	X	Returns laser emission status. Replay = ON OFF.
SOURce:TEMPerature:PROTec-tion:BASEplate:HIGH? {C F}		X	X	Returns maximum laser baseplate temperature without triggering a fault condition.
SOURce:TEMPerature:PROTec-tion:BASEplate:LOW? {C F}		X	X	Returns minimum laser baseplate temperature without triggering a fault condition.
SOURce:TEMPerature:PROTec-tion:DIODE:HIGH? {C F}		X		Returns maximum laser diode temperature without triggering a fault condition.
SOURce:TEMPerature:PROTec-tion:DIODE:LOW? {C F}		X		Returns minimum laser diode temperature without triggering a fault condition.
SOURce:TEMPerature:DIODE? {C F}		X		Returns present laser diode temperature.
SOURce:TEMPerature:DIODE:DSET-point? {C F}		X		Returns TEC temperature set point for the laser diode.
SOURce:TEMPerature:APRobe?		X		Returns thermoelectric cooler (TEC) status. Replay = ON OFF.
SOURCE:CURRent:LIMit:LOW?		X		Returns laser diode threshold current in amperes.

# SECTION EIGHT: TROUBLESHOOTING

## Introduction

If you experience problems with the OBIS laser system, refer to Table 8-1, below. If you are not successful in solving the problem or need further assistance, call Coherent Technical Support at 1.800.367.7890 (1.408.764.4557 outside the U.S.), e-mail [Product.Support@Coherent.com](mailto:Product.Support@Coherent.com), or contact your local Coherent service representative (see [www.Coherent.com](http://www.Coherent.com) for worldwide contacts).




---

### CAUTION!

Take appropriate ESD precautions when handling and installing a laser. Refer to “Electrical Safety” (p. 1-3) for a complete description of ESD precautions.

---

## Troubleshooting Procedures

Listed below are possible problems, along with a reference to the associated troubleshooting checklist.

*Table 8-1. Troubleshooting Procedures*

Problem	Reference
No output power from the laser	Checklist 1 (p. 8-2)
Laser output power is lower than expected	Checklist 2 (p. 8-3)
Base plate temperature error	Checklist 3 (p. 8-4)
The OBIS Remote is powered up and switched to the ON position, but the OBIS laser head is not emitting a beam and remains in standby mode	Checklist 4 (p. 8-4)
The LED on top of the OBIS laser is not functioning	Checklist 5 (p. 8-4)

## Checklist 1:

### No output power from the laser.

If there is no output power from the laser, execute the following steps, in the order listed:

- [ ] Cycle laser power, OFF/ON.
- [ ] Many customers are hitting “AUTOSTART=OFF” when using the laser head directly with a power supply. The solution is to connect to a PC and use OBIS Connection to set “AUTOSTART=ON” so the laser will power-on when the 12V power to the back panel is applied.
- [ ] Check to make sure the laser shutter is open and that nothing is obstructing the output aperture on the laser. ***Follow proper safety procedures when inspecting the output aperture and the shutter on the laser.***
- [ ] Check for fault status LEDs on the OBIS Remote and directly on the OBIS laser head—refer to “Status LED Indicator” (p. 2-7) and “Status LED Indicators” (p. 2-15). If using a computer interface, check fault status either in the OBIS Connection software or by using the remote command SYST:FAUL? For more information, refer to “System Fault Query” (p. 7-12).
- [ ] Check the “laser on” status through the LED indicators on the OBIS Remote and on the OBIS laser head. The “laser on” status can also be checked through either the OBIS Connection software or through the remote command SOUR:AM:STAT?
- [ ] Check the operating mode of the laser by using either the OBIS Connection software or the remote command SOUR:AM:SOUR? For normal CW mode, the laser should be in “CW Power” mode in the OBIS software or should reply with “CWP” when using the remote command.
- [ ] Check the set power level of the laser using either the OBIS Connection software or the remote command SOUR:POW:LEV:IMM:AMPL? This should reply with the power level that the laser is currently set to output.
- [ ] Contact Coherent Technical Support—refer to “Introduction” (p. 8-1) for contact information.



**Checklist 2:**  
**Laser output power is**  
**lower than expected.**

If the laser output power is lower than expected, execute the following steps, in the order listed:

- [ ] Cycle laser power, OFF/ON.
- [ ] Check to make sure the laser shutter is fully open and that nothing is obstructing the output aperture on the laser. *Follow proper safety procedures when inspecting the output aperture and the shutter on the laser.*
- [ ] Check for fault status LEDs on the OBIS Remote and directly on the OBIS laser head—refer to “Status LED Indicators” (p. 2-15). If using a computer interface, check fault status in either the OBIS Connection software or by using the remote command SYST:FAUL? For more information, refer to “System Fault Query” (p. 7-12).
- [ ] Check the operating mode of the laser using either the OBIS Connection software or the remote command SOUR:AM:SOUR? For normal CW mode, the laser should be in “CW Power” mode in the OBIS software or should reply with “CWP” using the remote command.
- [ ] Check the set power level of the laser using either the OBIS Connection software or the remote command SOUR:POW:LEV:IMM:AMPL? This should reply with the power level that the laser is currently set to output.
- [ ] Confirm the output power level of the OBIS laser using an external power meter that is calibrated and is appropriate for the output power level from the laser.
- [ ] Check for the calibration status bit. If it is not set, the laser may need to be re-calibrated.
- [ ] Contact Coherent Technical Support—refer to “Introduction” (p. 8-1) for contact information.

**Checklist 3:**

**Base plate temperature error.**

If there is a base plate temperature error, execute the following steps, in the order listed:

- [ ] Cycle laser power, OFF/ON.
- [ ] Check the reported base plate temperature using either the OBIS Connection software or the remote command SOUR:TEMP:BAS?. The maximum baseplate temperature should be 40°C.
- [ ] Verify the laser head is mounted securely to a properly-sized heat sink—refer to “Heat Sink Requirement” (p. 3-12). The laser head and heat sink should have metal-to-metal contact. Thermal compound is not necessary when mounting the laser. Verify that the base plate is mounted to a heat sink that has a smooth surface.
- [ ] Verify that the ambient temperature does not exceed 40°C.

**Checklist 4:**

**The OBIS Remote is powered up and switched to the ON position, but the OBIS laser head is not emitting a beam and remains in Standby mode.**

- [ ] If the key switch on the OBIS Remote is in the ON position when the OBIS Remote is turned on, the key switch must be cycled for the laser to come out of standby mode. Turn the key switch to the STANDBY position and then back to the ON position. The LED on the OBIS laser should turn white and the laser will begin emission after a 5-second delay.
- [ ] Check to make sure the laser is not turned off through its software interface. To do that, open the OBIS Connection software and press the Start or All Start button.

**Checklist 5:**

**The LED on top of the OBIS laser is not functioning.**

- [ ] Make sure the LED has not been disabled through the OBIS Connection software. With the laser powered up and connected to a computer, the LED setting can be found under the Preferences tab in the OBIS Connection software.

## SECTION NINE: REPACKING PROCEDURE

This section describes the factory-recommended repacking procedure for both the OBIS laser system (p. 9-2) and OBIS FP laser system (p. 9-3). The appropriate procedure must be followed if the laser system is to be shipped to another location after initial installation, or returned to the factory for service.



**NOTICE!**

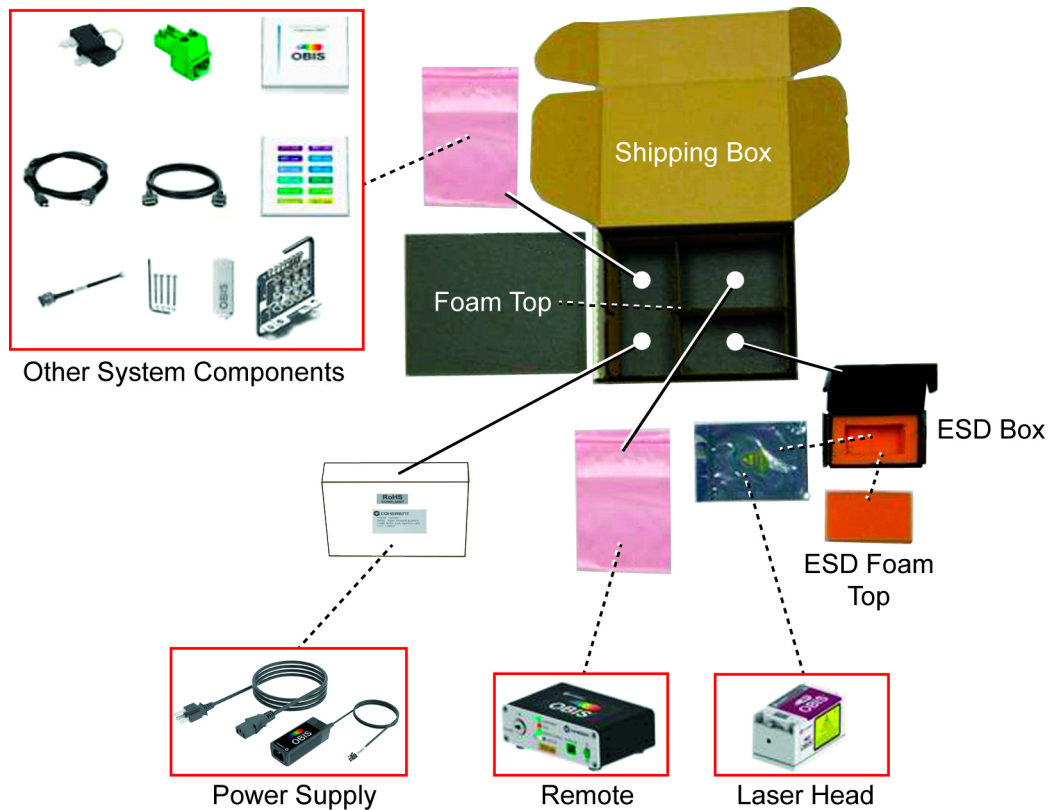
**Coherent recommends that the shipping box and packing materials be saved after initial purchase, as they will be required if the laser needs to be shipped or returned.**

The OBIS laser system requires one shipping box and includes the components listed in the following table.

**Table 9-1. Components Shipped with Different OBIS Laser System Configurations**

Item Description	Included With				
	Laser Head	Laser System	OBIS Remote	OBIS 6-Laser Remote	Spare Parts Accessory Bag
Laser head	X	X			
Laser mounting bolts/washers (4 each)	X	X			
OBIS Remote		X	X		
OBIS 6-Laser Remote				X	
Laser Safety and Software Installation Guide	X	X	X		X
Keys for OBIS Remote (2 each)		X	X	X	X
Interlock, shorted, for OBIS Remote		X	X	X	X
Wavelength labels for OBIS Remote		X	X	X	X
Flash stick for software control		X	X	X	X
Mounting brackets/hardware for OBIS Remote		X	X	X	
Cable, SDR, laser head to OBIS Remote (1 meter)		X			
USB cable, Type A to Type Mini-B (1.8 meters)		X	X		
Power supply, 110/220V AC, 12V DC, IEC-320		X	X	X	
Power cord, USA to IEC-320		X	X	X	
Cable, 8-pin, I/O for OBIS Remote (1 meter)					X
Cable, 2-pin, power for OBIS 6-Laser Remote (1 meter) (6 each)				X	X
Heat sink, with fan/hardware	order separately				
Laser emission indicator with interlock connector	order separately				
Cable, SDR, laser head to OBIS Remote (3 meters)	order separately				

## OBIS Repacking Procedure



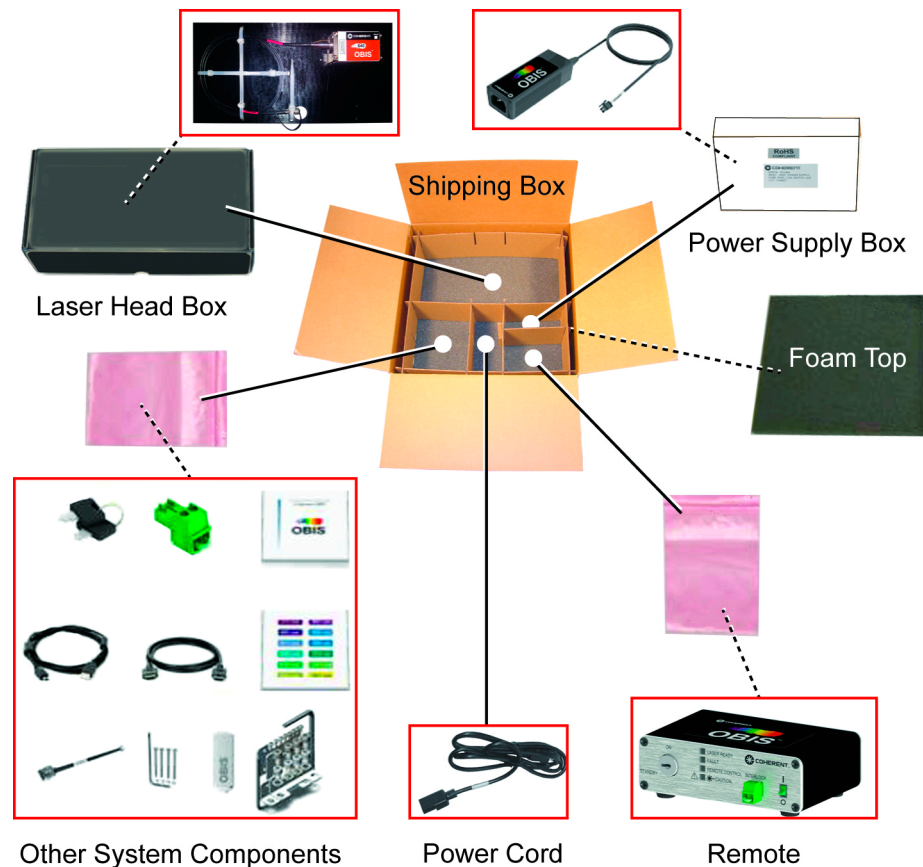
**Figure 9-1. OBIS Shipping Container Showing Component Placement**

When using the following procedure, refer to Figure 9-1, above, for proper placement of all components within the shipping box.

1. Place the laser head in the silver ESD bag and then position the ESD bag inside the ESD box.
2. Place the ESD foam top over the ESD bag, close the box, and secure the box with tape.
3. Place the ESD box in the lower right compartment of the shipping box.
4. Place the OBIS Remote (if present) in the ESD pink poly bag and then position the bag in the upper right compartment of the shipping box.
5. Place the power supply (if present) in the white box and then position the box in the left compartment of the shipping box.
6. Place all other system components in the ESD pink poly bag and then position the bag in the left compartment of the shipping box.

7. Position the foam top in the shipping box, close the shipping box, and secure the box with tape.
8. *If you are returning the system to Coherent for service:*
  - Contact Coherent Customer Service (1.800.343.4912) to obtain an RMA number.
  - Include the RMA number on the shipping label.

## OBIS FP Repacking Procedure



**Figure 9-2. OBIS FP Shipping Container Showing Component Placement**

When using the following procedure, refer to Figure 9-2, above, for proper placement of all components within the shipping box.



---

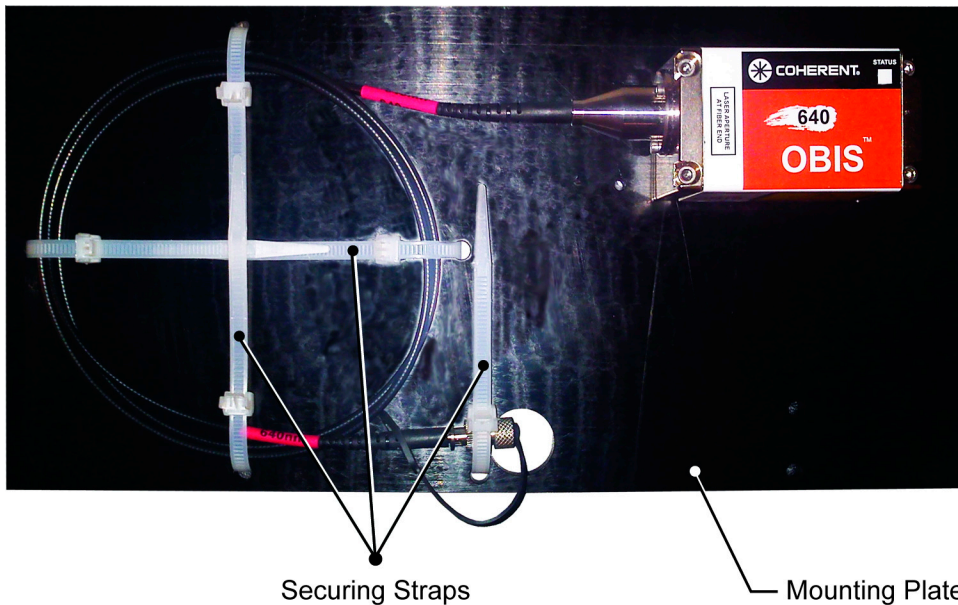
**NOTICE!**

**Do not touch the laser fiber output!**

**Nitrile gloves should be used whenever handling the fiber output.**

---

1. Secure the laser head to the mounting plate (refer to the following figure).



**Figure 9-3. OBIS FP Laser Head Secured to the Mounting Plate**

2. Place the secured laser head in the black laser head box, close the box, and secure the box with tape.
3. Place the laser head box in the top compartment of the shipping box.
4. Place the OBIS Remote (if present) in the ESD pink poly bag and then position the bag in the lower right compartment of the shipping box.
5. Place the power supply (if present) in the white power supply box and then position the box in the right middle compartment of the shipping box.
6. Place all other system components in the ESD pink poly bag and then position the bag in the lower left compartment of the shipping box.

7. Position the foam top in the shipping box, close the shipping box, and secure the box with tape.
8. *If you are returning the system to Coherent for service:*
  - Contact Coherent Customer Service (1.800.343.4912) to obtain an RMA number.
  - Include the RMA number on the shipping label.





## APPENDIX A: WARRANTY

Coherent, Inc. warrants OBIS laser systems to the original purchaser (the Buyer) only; that the laser system that is the subject of this sale, (a) conforms to Coherent's published specifications, and (b) is free from defects in materials and workmanship.

Laser systems are warranted to conform to Coherent's published specifications and to be free from defects in materials and workmanship for a period of twelve (12) months\*. Replacement units shipped within warranty, carry the remainder warranty of the failed unit.

### **Responsibilities of the Buyer**

The Buyer is responsible for providing the appropriate utilities and an operating environment as outlined in the product literature. Damage to the laser system caused by failure of Buyer's utilities or failure to maintain an appropriate operating environment, is solely the responsibility of the Buyer and is specifically excluded from any warranty, warranty extension, or service agreement.

The Buyer is responsible for prompt notification to Coherent of any claims made under warranty. In no event will Coherent be responsible for warranty claims made later than seven (7) days after the expiration of warranty.

### **Limitations of Warranty**

The foregoing warranty shall not apply to defects resulting from any of the following conditions:

- Components and accessories manufactured by companies other than Coherent, which have separate warranties
- Improper or inadequate maintenance by the Buyer
- Buyer-supplied interfacing
- Operation outside the environmental specifications of the product
- Unauthorized modification or misuse
- Improper site preparation and maintenance
- Opening the housing

Coherent assumes no responsibility for customer-supplied material. The obligations of Coherent are limited to repairing or replacing, without charge, equipment that proves to be defective during the warranty period. Replacement sub-assemblies may contain reconditioned parts. Repaired or replaced parts are warranted for the duration of the original warranty period only. The warranty on parts purchased after expiration of system warranty is ninety (90) days. This warranty does not cover damage due to misuse, negligence or accidents; or damage due to installations, repairs or adjustments not authorized specifically by Coherent.

This warranty applies only to the original purchaser at the initial installation point in the country of purchase, unless otherwise specified in the sales contract. The warranty is transferable to another location or to another customer only by special agreement, which will include additional inspection or installation at the new site. Coherent disclaims any responsibility to provide product warranty, technical or service support to a customer that acquires products from someone other than Coherent or an authorized representative.

THIS WARRANTY IS EXCLUSIVE IN LIEU OF ALL OTHER WARRANTIES, WHETHER WRITTEN, ORAL OR IMPLIED, AND DOES NOT COVER INCIDENTAL OR CONSEQUENTIAL LOSS. COHERENT SPECIFICALLY DISCLAIMS THE IMPLIED WARRANTIES OF MERCHANTABILITY AND FITNESS FOR A PARTICULAR PURPOSE.

## APPENDIX B: PARTS LIST

The following parts can be ordered by calling our Technical Support Hotline at 1.800.367.7890 (1.408.764.4557 outside the U.S.), e-mailing [Product.Support@Coherent.com](mailto:Product.Support@Coherent.com), or contacting your local Coherent service representative (see [www.Coherent.com](http://www.Coherent.com) for world-wide contacts). When communicating with our Technical Support Department via the web or telephone, the Support Engineer responding to your request will require the model and laser head serial number of your laser system.

*Table B-1. Parts List*

Description	Part Number
OBIS Remote, Single Laser, Power Supply included. Laser-to-Remote cable (SDR) not included.	1173961
OBIS Power Supply, 110V/220 VAC, 12VDC, IEC-320 input. Power cord to wall not included.	1184491
OBIS 6-Laser Power Supply, 110V/220 VAC, 12VDC, IEC-320 input. Power cord to wall not included.	1211389
Power Cord, USA wall-plug to IEC-320 plug, 3 meter	6005-0059
Power Cord, Europe wall-plug to IEC-320 plug, 3 meter	1150025
OBIS, SDR Cable, Laser-to-Remote, 1 meter	1179451
OBIS, SDR Cable, Laser-to-Remote, 3 meters	1179858
USB Cable, 1.8 meter (USB-to-USB)	1108906
OBIS, Mounting Brackets for OBIS Remote	1182608
OBIS, Accessory Spare Parts for OBIS Remote	1190348
OBIS, Interlock Laser Warning Light Assy for OBIS Remote	1190901
OBIS, Heat Sink Mount with Fan	1193289
OBIS Remote, 6-Laser, with Power Supply and Cables	1203909



# APPENDIX C: ACCESSORIES

## Power Meter Accessories

Coherent offers a variety of instruments for laser test and measurement. For additional detailed information, including product selection guides, visit our web site: [www.Coherent.com](http://www.Coherent.com).

For the most common diagnostics need—measuring the output power of the OBIS—we recommend two different types of power meters that are ideal fits to the OBIS product family.

### First Recommendation

We have a great product combination that covers that entire wavelength range at these power levels. The PS10Q sensor is a temperature-stabilized thermopile sensor designed for measurements in the ~100  $\mu$ W to 1W region.

We recommend the FieldMaxII-TOP to go with the PS10Q. An affordable, versatile, easy-to-use digital meter designed for field service and production applications, this meter features an easy-to-read LCD with a backlight, as well as direct button-driven commands for simple, no-hassle use.



PS10Q High-Sensitivity Thermopile Sensor (RoHS)	Part Number 1098400
---	---------------------



FieldMaxII-Top™ Laser Power and Energy Meter (RoHS)	Part Number 1098580
---	---------------------

**Alternative Recommendation**

LaserCheck is a hand-held, inexpensive laser power meter specifically designed to provide power measurements in a small, light-weight, self-contained package that can easily be stored in a pocket or tool kit. With its compact size, it enables measurements at places in optical set-ups where a standard detector head would not fit. With its built-in attenuator, this device is ready to measure output power from 0.5  $\mu$ W to 1W.



LaserCheck™ Handheld Power Meter (RoHS)	Part Number 1098293
---	---------------------

**NOTE:** LaserCheck does not measure below 400 nm, so it is not recommended for the OBIS 375 system.

# GLOSSARY

°C	Degrees centigrade or Celsius
°F	Degrees Fahrenheit
$\Omega$	Ohm(s)
$\mu$	Micron(s)
$\mu\text{m}$	Micrometer(s) = $10^{-6}$ meters
$\mu\text{rad}$	Microradian(s) = $10^{-6}$ radians
$\mu\text{sec}$	Microsecond(s) = $10^{-6}$ seconds
$1/e^2$	Beam diameter parameter = 0.13534
AC	Alternating current
Amp	Ampere(s)
BNC	Type of connector
CCB	Coherent Connection Bus, a RS-485 communication bus
CDRH	Center for Devices and Radiological Health
cm	Centimeter(s)
CW	Continuous wave
DC	Direct current
DDL	Direct Diode Laser
ESD	Electrostatic Discharge
g	Gram(s) or earth's gravitational force (gravity)
GUI	Graphical user interface
HeNe	Helium Neon
Hz	Hertz or cycles per second (frequency) (= 1/pulse period)
IR	Infrared (wavelength)
I/O	Input/Output
kg	Kilogram(s) = $10^3$ grams
kHz	Kilohertz = $10^3$ hertz
kOhm	Kilohm(s) = $10^3$ ohms
LCD	Liquid Crystal Display
LED	Light emitting diode
LS version	OBIS laser, based on Optically Pumped Semiconductor Laser (OPSL) technology
LX version	OBIS laser, based on Direct Diode Laser (DDL) technology

m	Meter(s) (length)
mA	Milliamp(s) = $10^{-3}$ Amperes
mAmp	Milliampere(s)
MHz	Megahertz = $10^6$ hertz
mm	Millimeter(s) = $10^{-3}$ meters
mrاد	Milliradian(s) = $10^{-3}$ radians (angle)
ms	Millisecond(s) = $10^{-3}$ seconds
mV	Millivolt(s)
MVP	Modulation and variable power
mW	Milliwatt(s) = $10^{-3}$ Watts (power)
NA	Numerical aperture
nm	Nanometer(s) = $10^{-9}$ meters (wavelength)
N·m	Newton meter

OBIS Remote

A dedicated Coherent device that serves as a communication gateway to a single laser head and provides a CDRH-compliant keyswitch and interlock capabilities.

OEM	Original equipment manufacturer
OPSL	Optically Pumped Semiconductor Laser
oz·in.	Ounce inches

rms	Root mean square (effective value of a sinusoidal wave)
RMA	Return material authorization

TEC	Thermo-electric cooler
TEM	Transverse electromagnetic mode (cross-sectional laser beam mode)
TTL	Transistor-transistor logic

UV	Ultra violet
----	--------------

V	Volt(s)
VAC	Volts, alternating current
VDC	Volts, direct current

W	Watt(s) (power)
---	-----------------



# INDEX

## A

- Advanced procedures
  - CDRH feature 6-1
  - OBIS communications through
    - HyperTerminal 6-7
  - System standby and sleep mode 6-6
- Analog
  - Control, CW operation 4-4
  - Modulation, OBIS laser oscilloscope traces 4-7
- Auto start (OBIS Remote)
  - Enabling 6-3
  - Switch 2-22

## B

- Back panel
  - Laser head 2-5
  - OBIS 6-Laser Remote 2-29
  - OBIS Remote 2-16
- Bit definitions
  - Fault code 7-13
  - Status code 4-11
- Broadcast commands 7-8
- Buyer responsibilities A-1

## C

- CDRH feature
  - Disabling CDRH 6-2
  - Enabling auto start 6-3
- China RoHS
  - Date of manufacture 1-15
  - Table of restricted hazardous substances 1-15
- Classification, laser 1-8
- Code, status 7-11
- Command and queries 7-8
  - DDL-specific commands 7-21
- Command prompt 7-7
- Commands
  - Broadcast 7-8
  - DDL-specific 7-21
  - OBIS, optional 7-21
  - Supported by laser type 7-8
- Commands and queries
  - Mandatory command and queries 7-9
  - OBIS common commands and queries 7-15
  - OBIS optional commands 7-21
- Communication port selection 7-3
- Configurations, laser head 2-8
- Connectors
  - DC supply (laser head) 2-6

- Fan (laser head) 2-6
- I/O (OBIS Remote) 2-17
- Modulation in (OBIS Remote) 2-21
- Power in (OBIS 6-Laser Remote) 2-29
- Power in (OBIS Remote) 2-17
- Power out (OBIS 6-Laser Remote) 2-30
- RS-232 (OBIS Remote) 2-21
- SDR (OBIS Remote) 2-18
- SDR connector (laser head) 2-6
- USB (laser head) 2-7
- USB (OBIS Remote) 2-22

## Constant

- Current, CW operation 4-4
- Power, CW operation 4-2
- Control and queries 7-26
- Control commands, OBIS 7-27
- Control, key 1-10
- CW operation 4-2
  - Analog control 4-4
  - Constant current 4-4
  - Constant power 4-2

## D

- DC supply connector 2-6
- DDL-specific commands 7-21
- Declaration of Conformity 1-6, 1-7
- Default settings, factory 4-11
- Device selection syntax 7-6
- Digital modulation, OBIS laser oscilloscope traces 4-8
- Dimensions 2-34
  - Heat sink 2-35
  - Laser head 2-36
  - OBIS 6-Laser Remote 2-41
  - OBIS Remote 2-39
  - OBIS Remote (with mounting brackets) 2-40
- Diode
  - Set point temperature query 7-23
  - Temperature query 7-22
- Disabling CDRH 6-2
- Drivers, USB 5-1

## E

- Emission, laser 1-8
- Enabling auto start (OBIS Remote) 6-3
- Error codes and description strings 4-12
- External modulation 7-20

## F

- Factory default settings 4-11
- Fan connector 2-6

## Coherent OBIS Operator's Manual

Fault code bit definitions 7-13  
Fault codes (OBIS Remote and laser head) 7-23  
Front panel  
    Laser head 2-4  
    OBIS 6-Laser Remote 2-26  
    OBIS Remote 2-13

### G

Glasses, safety 1-2

### H

Handshake, message completion 7-4  
Hardware setup 4-1  
Head connections, USB 5-1  
Heat sink  
    Dimensions 2-35  
    Features 2-11  
    Installation 3-2  
    Optional 2-12  
    Requirement 3-12  
Host command quick reference 7-1  
Host interface  
    Commands and queries 7-8  
    Controls and queries 7-26  
    Host command quick reference 7-1  
Host interface commands and queries  
    DDL-specific commands 7-21  
    Mandatory commands and queries 7-9  
    OBIS common commands and queries 7-15  
    OBIS optional commands 7-21  
Host interface message considerations  
    Broadcast commands 7-8  
    Command prompt 7-7  
    Communication port selection 7-3  
    Device selection syntax 7-6  
    Message completion handshake 7-4  
    Message syntax 7-5  
    Message terminators 7-5  
Humidity 2-33

### I

I/O connector pinout specifications  
    OBIS 6-Laser Remote 2-30  
    OBIS Remote 2-18  
IEEE-488.2 mandated commands/queries 7-9  
Indicator, status LED  
    Laser head 2-7  
    OBIS 6-Laser Remote 2-27  
    OBIS Remote 2-15  
Installation 3-1  
    Heat sink 3-2  
    OEM laser head only 6-4  
    Standard 3-1

### Interlock

    Circuit and key switch diagram (LX laser only) 1-9

Control (OBIS 6-Laser Remote) 2-32  
Control (OBIS Remote) 2-23  
Jumper (OBIS 6-Laser Remote) 2-30  
Jumper (OBIS Remote) 2-15

### Internal temperature

    Limit queries 7-22  
    Query 7-23

### K

#### Key

    Control (OBIS Remote and OBIS 6-Laser Remote) 1-10  
    Switch (OBIS 6-Laser Remote) 2-26  
    Switch (OBIS Remote) 2-14

### L

#### Laser

    Emission, classification 1-8  
    Emission, indicators 1-11  
    Safety 1-1  
    Safety (French translation) 1-16  
    System components 2-1  
Laser head 2-3  
    Back panel 2-5  
    Configurations 2-8  
    DC supply connector 2-6  
    Fan connector 2-6  
    Fault codes 7-23  
    Front panel 2-4  
    Maximum thermal impedance of heat sink needed 3-12  
    Modulation 2-24  
    SDR connector 2-6  
    Specifications 2-10  
    Status LED indicator 2-7  
    Thermal dissipation data 3-12  
    Tightening pattern 3-7  
    USB connector 2-7  
Laser safety (French translation) 1-16  
Location of safety labels 1-14

### M

Mandatory commands and queries 7-9  
Message  
    Completion handshake 7-4  
    Syntax 7-5  
    Terminators 7-5  
Message considerations  
    Broadcast commands 7-8  
    Command prompt 7-7  
    Communication port selection 7-3  
    Device selection syntax 7-6  
    Message completion handshake 7-4  
    Message syntax 7-5  
    Message terminators 7-5  
Modulation

- External 7-20
  - Laser head 2-24
  - Modulation in connectors 2-21
  - OBIS laser oscilloscope traces
    - Analog 4-7
    - Digital 4-8
- O**
- OBIS**
- Common commands and queries 7-15
  - Communications through HyperTerminal 6-7
  - Control commands 7-27
  - Laser analog modulation, oscilloscope traces 4-7
  - Laser digital modulation, oscilloscope traces 4-8
  - Laser system components 2-1
  - Mandatory commands/queries 7-10
  - Optional commands 7-21
  - Query Commands 7-28
  - Shipping container 9-2, 9-3, 9-4
  - Status LED states 2-10
- OBIS 6-Laser Remote 2-25**
- Auto start jumper and fuse replacement 2-31
  - Back panel 2-29
  - Front panel 2-26
  - Interlock control 2-32
  - Interlock jumper 2-30
  - Key switch 2-26
  - Power in connector 2-29
  - Power ON/OFF switches 2-29
  - Power out connectors 2-30
  - Remote interlock 2-32
  - Specifications 2-32
  - Status LED indicator 2-27
- OBIS Remote 2-13**
- Auto start switch 2-22
  - Back panel 2-16
  - Fault codes 7-23
  - Front panel 2-13
  - I/O connector 2-17
  - Interlock jumper 2-15
  - Key switch 2-14
  - Laser head (SDR) connector 2-18
  - Laser head modulation 2-24
  - Modulation in connectors 2-21
  - Power ON/OFF switch 2-16
  - RS-232 connector 2-21
  - Specifications 2-24
  - Status LED indicators 2-15
  - USB connector 2-22
- OEM laser head only installation**
- Adding optional fan power to the laser head 6-5
  - Connecting power and the optional USB cable 6-5
  - Mounting hardware recommendation 6-5
  - Power supply requirements 6-6
- Operation**
- CW 4-2
  - Pulsed 4-5
- Operational commands/queries 7-19**
- Optical**
- Safety 1-1
  - Safety glasses 1-2
  - Schematic (LS laser only) 2-9
- Optional heat sink 2-12**
- P**
- Parts list B-1**
- Power in connector**
- OBIS 6-Laser Remote 2-29
  - OBIS Remote 2-17
- Power meter accessories C-1**
- Power ON/OFF switches**
- OBIS 6-Laser Remote 2-29
  - OBIS Remote 2-16
- Power out connectors (OBIS 6-Laser Remote) 2-30**
- Power supply 2-12**
- Specifications 2-12
- Product repacking procedure 9-1**
- Prompt, command 7-7**
- Pulsed operation 4-5**
- Analog modulation 4-6
  - Digital modulation 4-7
  - Mixed modulation 4-8
- Q**
- Query commands, OBIS 7-28**
- Quick reference, host command 7-1**
- R**
- Radiation exposure 1-11**
- Receiving and inspection xiv, xviii**
- Remote control**
- Connecting USB/RS-232 5-1
  - RS-232 4-10
  - USB 4-10
- Remote interlock (OBIS 6-Laser Remote) 2-32**
- Repacking procedure, product 9-1**
- Responsibilities of the buyer A-1**
- RoHS compliance 1-15**
- RS-232 connector 2-21**
- S**
- Safety**
- Features 1-4
  - Glass OD table 1-1
  - Glasses 1-2
  - Labels 1-14
  - Laser 1-1
  - Laser (French translation) 1-16
  - Optical 1-1
- Safety features 1-4**
- CDRH/IEC 60825-1 compliance 1-4
  - Declaration of Conformity 1-6, 1-7
  - Key control 1-10

- Laser emission and classification 1-8
- Laser emission indicators 1-11
- Location of safety labels 1-14
- Protective housing 1-8
- Radiation exposure 1-11
- Remote interlock 1-8
- RoHS compliance 1-15
- Shutter 1-12
- Waste Electrical and Electronic Equipment (WEEE, 2002) 1-13
- Safety labels, location 1-14
- SDR connector 2-6
- Session control commands 7-10
- Set/query TEC enable command 7-21
- Shipping container, OBIS 9-2, 9-3, 9-4
- Shutter
  - Laser 1-12
  - Open and closed positions 1-12
- Specifications
  - I/O connector pinout 2-18, 2-30
  - Laser head 2-10
  - OBIS 6-Laser Remote 2-32
  - OBIS Remote 2-24
  - Power supply 2-12
- Standard installation
  - Adding optional fan power to the laser head 3-10
  - Connecting optional USB/RS-232 3-11
  - Connecting power 3-10
  - Connecting the interlock to the OBIS Remote 3-11
  - Connecting the SDR cable 3-9
  - Mounting the laser head 3-5
- Standby and sleep mode, system 6-6
- Status code 7-11
  - Bit definitions 4-11
- Status LED indicator
  - Laser head 2-7
  - OBIS 6-Laser Remote 2-27
- Support commands by laser type 7-8
- Switches
  - Auto start (OBIS Remote) 2-22
  - Key (OBIS 6-Laser Remote) 2-26
  - Key (OBIS Remote) 2-14
  - Power On/OFF (OBIS 6-Laser Remote) 2-29
  - Power ON/OFF (OBIS Remote) 2-16
- Symbols used in this document xii
- Syntax
  - Device selection 7-6
  - Message 7-5
- System
  - Description 2-2
  - Diagram 2-7
  - Features 2-2
  - Information queries 7-15
  - Standby and sleep mode 6-6
  - State commands/queries 7-18
- T**
- Terminators, message 7-5
- Thermal
  - Dissipation data, laser head 3-12
  - Maximum impedance of heat sink needed to cool laser 3-12
- Tightening pattern, laser head 3-7
- Troubleshooting procedures
  - Base plate temperature error 8-4
  - Laser output power is lower than expected 8-3
  - No output power from the laser 8-2
  - The LED on top of the OBIS laser is not functioning 8-4
  - The OBIS remote is powered up and switched to the ON position, but the OBIS laser head is not emitting a beam and remains in Standby mode 8-4
- U**
- U.S. export control laws compliance xi
- USB
  - Connector 2-7
  - Drivers 5-1
  - Head connections 5-1
- USB and RS-232 remote control 4-10
- W**
- Warranty
  - Limitations of warranty A-1
  - Responsibilities of the buyer A-1
- Waste Electrical and Electronic Equipment (WEEE, 2002) 1-13



