

**FOR INFORMATION ONLY:
DO NOT MANUFACTURE
PARTS TO THIS DRAWING**

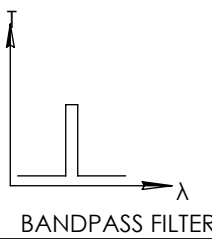

	VALUE
OPTICAL DENSITY	≥ 3.0
CENTER WAVELENGTH (CWL)	$400 \pm 2 \text{ nm}$
FULL WIDTH HALF MAX (FWHM)	$10 \pm 2 \text{ nm}$
MINIMUM TRANSMISSION	$\geq 30 \%$
BLOCKING	200 - 1200nm
SURFACE QUALITY	80-50
CONSTRUCTION	MOUNTED IN BLACK ANODIZED RING
COATING TYPE	TRADITIONAL COATED

SPECIFICATIONS SUBJECT TO CHANGE WITHOUT NOTICE
DIMENSIONS ARE FOR REFERENCE ONLY

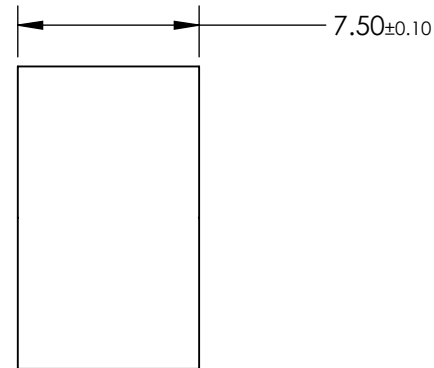
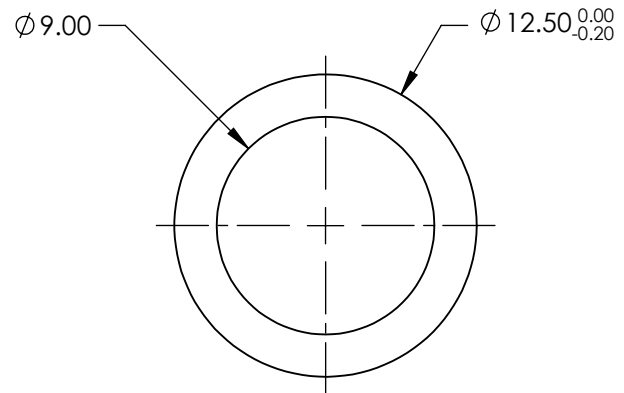
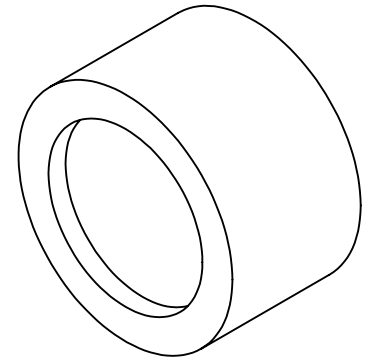

THIRD ANGLE PROJECTION		TITLE	$\phi 12.5\text{mm}$, 400nm x 10nm, MOUNTED BANDPASS FILTER
ALL DIMS IN	mm	DWG NO	65617
			SHEET 1 OF 1