

NOTES:

1. ALLOWABLE OPTICAL MATERIAL:  
SCHOTT: Fused Silica 458/678
2. SURFACE S2 TO BE PARALLEL WITH SURFACE S1 TO < 3 ARCMIN
3. COATING (APPLY ACROSS COATING APERTURE)  
S1: PROTECTED GOLD  
Ravg ≥ 94% 700-800nm @ 0° AOI  
Ravg ≥ 97% 800-2,000nm @ 0° AOI

S2: NONE

4. ARROW ON EDGE POINTING TOWARDS SURFACE S1.

5. FINE GROUND SURFACE

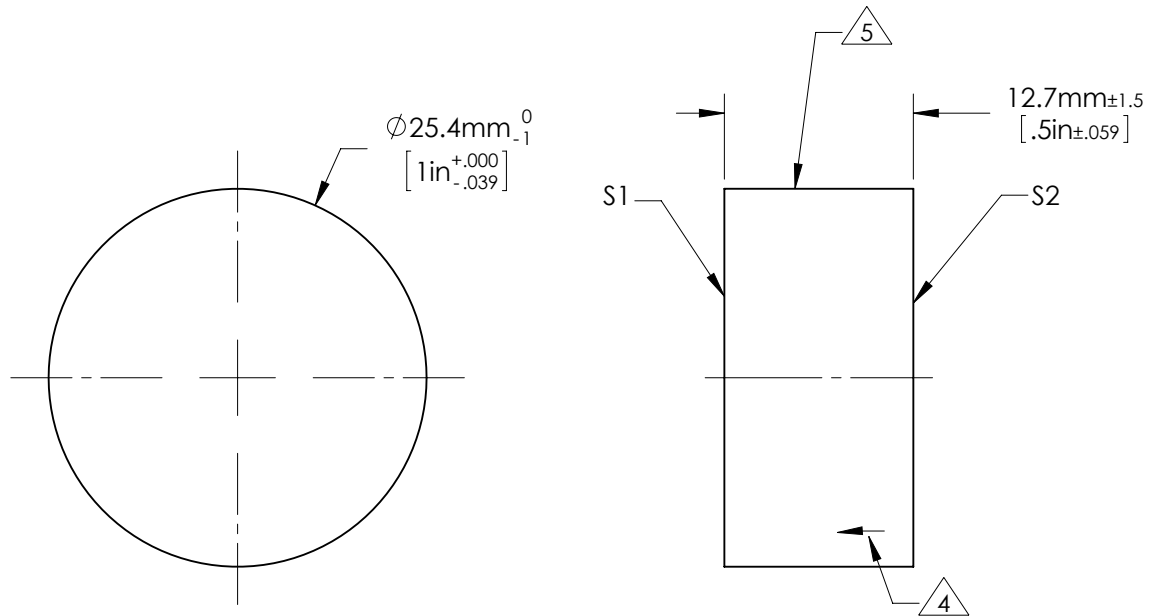

**FOR INFORMATION ONLY:  
DO NOT MANUFACTURE PARTS TO THIS DRAWING**

	S1	S2	EFL (AT 587.6nm)	NA	 <b>Edmund Optics®</b>	
SHAPE	PLANO	PLANO				
SURFACE ACCURACY AT 632.8nm	1/20 WAVE	NA	BFL (AT 587.6nm)	NA	TITLE	1/20λ Optical Flat, Fused Silica, 1inch Diameter PROTECTED GOLD
SURFACE QUALITY	60 - 40	COMMERCIAL POLISH			DWG NO	43408-566
CLEAR APERTURE	∅ 22.9	∅ 22.9	ALL DIMS IN	mm		
BEVEL MAX FACE	1.0 x 45°	1.0 x 45°				